



ASPIRCOMFORT PRO X 460H

INSTALLATION, USE AND MAINTENANCE MANUAL

1. GENERAL

1.1 INTRODUCTION

This manual was prepared with the aim of making the installation and management of your system as simple as possible.

By reading and applying the suggestions of this manual, you can achieve the best performance of the purchased product.

We would like to thank you for choosing to purchase one of our products.

Read this file carefully before performing any operation on the unit.

The unit must not be installed, nor must any operation be performed on it, without firstly reading and understanding the entirety of this manual. In particular it is necessary to adopt all of the precautions listed in the manual.

The documentation provided with the unit must be delivered to the system manager for safe keeping (at least 10 years) for future assistance, maintenance and repairs.

Unit installation must take into account the strictly technical needs for good operation, as well as any local legislation in force and specific requirements.

Make sure that when the unit is delivered there are no evident signs of damage caused by transport. If there is, state this on the delivery note.

This manual reflects the state of the technical standards at the time of sale and cannot be considered inadequate if updated at a later date based on new experiences. The Manufacturer reserves the right to update production and the manuals without being required to update previous ones, except in exceptional cases.

Contact the Manufacturer's Sales Office to receive further information or updates on/to the technical documentation and for any suggestions for improvement to this manual. All suggestions shall be strictly vetted.

1.2 FUNDAMENTAL SAFETY RULES



Remember that the use of products that use electrical energy and water requires certain fundamental safety rules to be followed:

- Unable and unassisted persons are forbidden from using the device.
- It is forbidden to touch the device in bare feet and with wet or damp parts of the body.
- Any cleaning activity is forbidden without firstly disconnecting the device from the electrical power mains by placing the system's main switch on 'off'.
- It is forbidden to modify the safety or regulation devices without the authorisation and indications of the device manufacturer.
- It is forbidden to pull, detach, twist the electrical cables coming out of the device, even if it is disconnected from the electrical power mains.

- It is forbidden to insert objects and substances through the air intake and supply grids.
- It is forbidden to open the access doors to the inside of the device, without firstly placing the system's main switch on 'off'.
- It is forbidden to release and leave packaging material within the reach of children as it is a potential source of danger.
- Comply with the safety distances between the machine and other devices or structures to guarantee enough access space to the unit for maintenance and assistance operations as stated herein.
- The unit's Power supply must be provided with electrical cables duly sized for the power of the unit. The voltage and frequency values must match those stated for the respective machines; all machines must be earthed according to the regulations in force in the various countries.
- Do not release R410Anell into the atmosphere: R410A is a fluorinated greenhouse gas, referred to in the Kyoto protocol, with a global warming potential (GWP) of =1975.

1.3 SYMBOLS

The symbols used in the following file quickly provide information necessary for the correct use of the unit.
Safety symbols



ATTENTION

Authorised personnel only. This means that the stated operations are important to safe machine operation.



DANGER

Risk of electric shock. This means that failure to comply with the warnings poses the risk of electric shock.



DANGER

This means that failure to comply with the warnings poses the risk of injury to the exposed persons.



WARNING

This means that failure to comply with the warnings poses the risk of damage to the unit or system.



DANGER

This means that there are moving parts and poses the risk of harm to exposed persons.

1.4 WARNINGS



The unit must be installed by qualified and authorised personnel according to the rules in force in the various countries.

If installation is not carried out, this could lead to a situation of danger.



Avoid installing the unit in very damp rooms or where there are large sources of heat.



On the electric side, to prevent any risk of electrocution, it is essential to disconnect the main switch before setting up the electrical connections and performing any maintenance operation.



If there are any water leaks from inside the unit, place the system's main switch on 'Off', close the water valves and contact the technical service.



Always use a dedicated power supply circuit; never use a power supply shared with other devices.



Always install an earth leakage circuit-breaker; failure to install this device could cause electric shock.



For the connection, use a sufficiently long cable to cover the entire distance without any connection; do not use extensions and do not apply other loads on the power supply, rather, always use a dedicated power supply circuit.



When the electrical cables are connected, make sure that the cables are arranged so that they do not press excessively on covers or electrical panels; any incomplete connection of the covers may cause overheating of the terminals.



Make sure that the earthing connection is set up; do not earth the device on distribution pipes.

Momentary high intensity overcurrents may damage the unit.



Installations made outside of the warnings set forth herein or use outside of the operating limits will instantly void the warranty.



Make sure that commissioning is carried out by personnel authorised by the company (see commissioning request form).

1.5 CONFORMITY

The CE marking (applied on each machine) certifies compliance with the following Community standards:

- Low Voltage Directive 2014/35/EC
- Electromagnetic Compatibility Directive 2014/30/EC
- RoHS2 2011/65/UE
- WEEE 2012/19/EC

1.6 RANGE

Code	Total Flow Rate/renewal air flow rate	Type of installation
AP20068	up to 460 m3/h	Horizontal

1.7 IDENTIFICATION



- The unit can be identified by the rating plate attached to the front bottom panel.
- On the packaging there is another identification rating plate with the unit model and the shipping references.

The rating plate on the packaging is not valid for tracking the product over the years after sale.

The removal, deterioration and illegibility of the rating plate attached to the unit makes machine identification and ordering spare parts very difficult, and therefore all future maintenance.

1.8 CONSTRUCTION FEATURES

The ASPIRCOMFORT PRO X 460H units are designed for room air renewal. The easy installation through two holes diam.160 mm and the high flow rate of fresh air, allows the application in situations such as residential buildings, schools, clinics, offices and all contexts where it is necessary to change the air; The thermodynamic recovery allows to have an integration with respect to the environmental climatic conditions, helping the air conditioning system to meet the internal comfort; In addition, the air introduced is always at a temperature close to or better than the environment, thus ensuring a higher perceived comfort; The unit consists of a monoblock including all components for proper operation: fans, cooling circuit with high-efficiency compressors, air filtration sections and high-efficiency countercurrent heat recovery unit.

ALL IN ONE

Complete unit capable of exchanging air and integrating the cooling thermal demands of the served rooms. The unit is complete with all components for its operation and ready to use.

UVC LAMP (AP20384 ACCESSORY) AND VOC SENSOR

The unit is equipped with a UVC lamp (AP20384 accessory), which enables a germicidal action to be carried out on the air introduced from outside through the effect of UVC; the lamp is activated automatically according to the quality of the room air.

VENTILATION

Fans with directly coupled brushless motor; the fans operate in various modes controlled mainly by the air quality sensor located inside the unit.

ACTIVE THERMODYNAMIC RECOVERY

The unit allows active recovery of energy from the exhaust air. The thermodynamic recovery allows, thanks to its cooling circuit, to supply energy to the environment in a higher quantity than that taken away by the ventilation for 90% of the unit's operation.

FILTRATION

There are 2 ePM1 filters on the extract air and the supply air; the filter on the supply air is placed after the coil to completely filter out any impurities in the supply air, On the outdoor air there is a Coarse pre-filter that protects the cleanliness of the unit.

STRUCTURE

Self-supporting sheet metal frame.

Self-supporting sheet metal structure, externally painted (in the visible versions), with polyethylene and EPDM thermal and acoustic insulation in between.

COOLING CIRCUIT

Built with braze welded copper, complete with: High efficiency BLDC compressor, Filter dryer, finned coils, electronic expansion valve, reversing valve and safety devices.

ADJUSTMENT

Electric panel on-board the unit with microprocessor and dedicated regulation. Fan management, temperature display and setpoint, timed dirty filter management. Management of defrosting algorithm optimised for operation at low external temperatures; Panel with graphic interface on board the machine and remote control included in the visible versions.

1.9 MAIN COMPONENTS OF THE UNIT

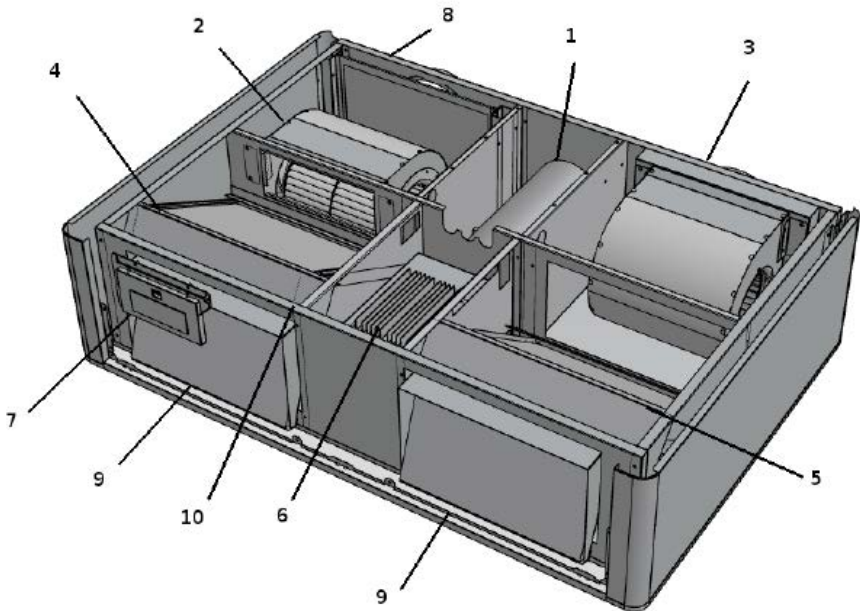

1. Compressor
2. Intake fan
3. Exhaust fan
4. Input coil
5. Exhaust coil
6. Electrical panel
7. Display
8. Outdoor air prefilter
9. Epm1 filters
10. UVC lamp (AP20384 accessory)

1.10 PACKAGING AND TRANSPORT

The units are prepared for transport secured to a wooden pallet and placed inside cardboard boxes. To facilitate relocation, the units have a wooden pallet and hooks on the base so it can be lifted and positioned in the place of installation. The unit can be stored in a room protected against the weather at temperatures of no less than 0°C up to a maximum of 40°C.

1.11 RECEIVING, CHECKING AND HANDLING



The unit is shipped fully loaded with refrigerant gas in the circuits and non-freezing oil in the compressors. In no case can there be water in the hydraulic circuits, since the unit is carefully emptied after final testing. Upon arrival the customer is required to inspect the unit, including the inside, to ensure that no damage occurred during transport; the unit left the factory in perfect conditions. If damage is found the customer must immediately report this to the courier by providing details on the extent of the damage on the delivery note, providing photographic evidence of the alleged damage and notifying the shipping company of any alleged damage by registered mail with return receipt.

The manufacturer will not be held liable for damage caused by transport even if he himself did the shipping. It is necessary to be very careful when handling the unit during unloading and positioning on site so as to avoid damage to the enclosure and the more delicate inside parts such as compressors, exchangers, etc. in any case keep the unit upright without tilting it. All of the indications on what precautions to take to prevent damage to the unit and the indications of its weight, are provided on the packaging. The packaging can be composed of various materials such as wood, cardboard or polyethylene (plastic). It is good practice to send them for disposal or recycling through specialised companies to reduce the impact on the environment.

1.12 DISASSEMBLY AND DISPOSAL



Do not take down or dispose of the product on your own. The product must be disassembled, demolished, disposed of by authorised personnel in compliance with local regulations.



2. INSTALLATION

2.1 INSTALLATION CONDITIONS



The unit must be installed based on national and local regulations governing the use of electrical devices and based on the following indications:

- install the unit inside residential buildings with room temperature between 0°C and 45°C;
- avoid areas near sources of heat, steam, inflammable and/or explosive gases and particularly dusty areas;
- install the unit in a place that is not subject to frost (the condensation water must be discharged not frozen, at a certain slope, using a trap);
- do not install the unit in zones with a high relative humidity rate (such as bathroom or toilet) to avoid condensation on the external surface;
- choose a place of installation where there is enough room around the unit for the connections of the air ducts and to perform maintenance activities;
- the consistency of the ceiling/wall/floor where the unit will be installed must be suitable for the weight of the unit and not cause vibrations.

The room chosen for installation must have:

- air duct connections;
- 230V single-phase electrical connection;
- connection for the condensation discharge.

2.2 UNIT POSITIONING

CEILING INSTALLATION

To mount the unit on the ceiling, it is necessary to:

- Remove the front grille by prying it upwards and pulling it out towards the bottom first;
- Remove the bottom panel through the front screws and out of the rear seats;
- Remove the screws on the side panels by removing the 4 screws on the front;
- Push the side out of the rear seats and remove it;
- Secure the unit to the ceiling, by the brackets, using suitable anchoring systems (plugs, chains...) and use a level to make sure it is level;
- Keep the unit at least 10mm away from the ceiling;
- Do not install the unit with the sides directly touching the walls to avoid possible noise from contact, insert rubber or neoprene strips in that case.

Provide enough space to perform maintenance activities: it must be possible to open the cover of the unit (from below).

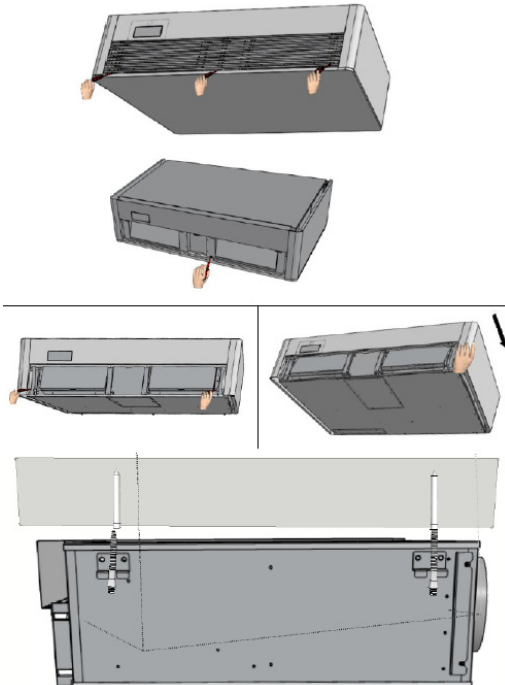

2.3 CONDENSATE DISCHARGE CONNECTION



Due to the thermodynamic heat recovery system of the dehumidification coils, the humidity contained in the indoor air condenses inside the unit.

For the correct operation of the heat recovery unit, it is therefore necessary to connect the condensate discharge to the hydraulic system (drain); furthermore, in order to allow the correct flow of the condensate water and to avoid air suction, the condensate discharges must be equipped with a special siphon to be supplied and installed by the installer;

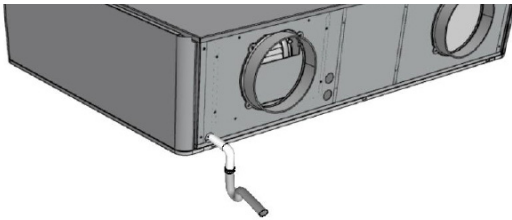

Condensate discharge exits as standard to the rear of the unit where there should be a hole in the wall as shown opposite;

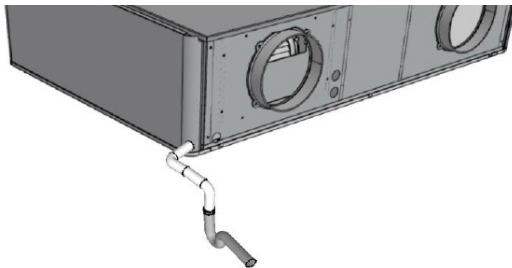

If it is not possible to take the condensate discharge outside, it is possible to exit on the right side of the unit using the pre-cut hole on the side;

For installation of the condensation discharge, follow these rules:

- set up a slope of at least 2% to the discharge pipe;
- allow the possibility of disconnecting the discharge pipe for any maintenance (especially with ceiling installation);
- make sure that the discharge end of the pipe is at least below the level of the trap water;
- make sure that the trap is always full of water;
- the H dimension as shown in the attached image must be at least $H=50\text{mm}$;

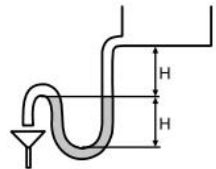

3 AERAILIC CONNECTIONS

3.1 AERAILIC ORIENTATIONS

The unit has 4 male circular rear fittings of different \varnothing and one rectangular front opening based on the size; To correctly connect the air ducts, refer to the following diagram and stickers on the unit.

Table of unit aeraulic connection diameters

Codes	AP20068
\varnothing Outdoor air mm	160 mm
\varnothing Exhaust mm	

It is advisable to install at least 500 mm of hose to avoid transmitting vibration and bothersome noises caused by the installation.

AIRFLOW CONFIGURATIONS

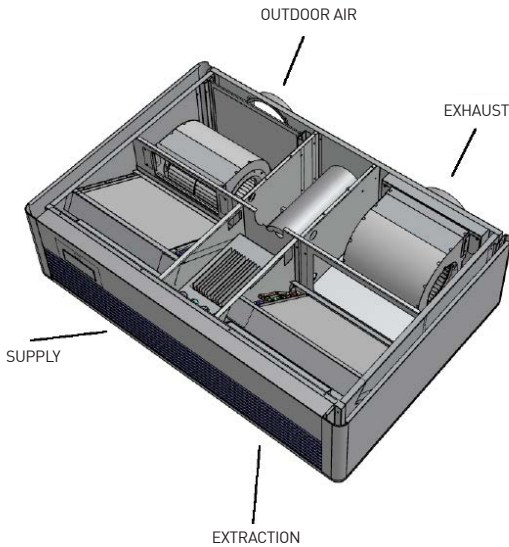

3.2 INSTALLATION OF EXTERNAL GRILLES

Cut off any excess part of the tube using a standard cutter.

To position the external grilles, proceed as follows:

- attach the chains to the end of the springs;
- fold the external dampers back on themselves;
- insert the arm into the hole until the damper protrudes completely outwards, holding the end of the chains with the other hand to prevent accidental falls;
- re-open the damper on the outside of the hole;
- turn the damper so that the flap is in the vertical position C and check that the closing mechanism works;
- pull the chains by tensioning the springs;
- use a wire cutter to cut off the excess chain links;
- fix the chain hook to the wall B.

Use only the grills supplied or grills with the same characteristics.

The dampers must be positioned with the flap vertical.

The dampers are different. A distinction must be made between the one on the inlet and the one on the outlet, depending on the direction of opening of the flaps.

Once the installation of the grilles is complete, check their opening (towards the inside of the duct for the intake grill "IN" and towards the outside of the duct for the exhaust grill "OUT"). Please note that the grilles open when the flow of outside air is activated to allow the cooling or heating function. For their testing, it is therefore essential to operate the air conditioning system for cooling or heating.

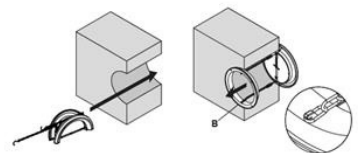
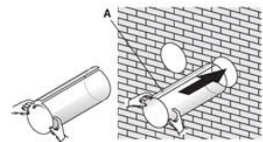
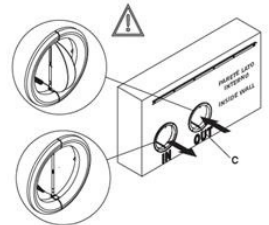
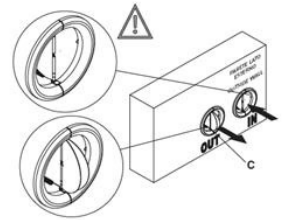

4 ELECTRICAL CONNECTIONS



4.1 GENERAL

- Before starting any operation to perform the electrical connection make sure that the unit is not electrically powered.
- Perform the necessary electrical connections referring exclusively to the wiring diagram attached to this manual.
- Install a suitable cut-off and breaker device exclusively serving the unit.
- It is essential for the unit to be earthed.
- Check that the electrical components chosen for installation (main switch, breakers, cable size and terminals) are suitable for the electrical power of the installed unit and that they take into account the start-up currents of the compressor in addition to the maximum achievable load. The relative data is stated on the attached wiring diagram and on the unit's rating plate.
- It is forbidden to enter the unit with electrical cables except where specified in this file.
- Use duly-sized electrical cables and conductors that comply with the regulations in force in the various countries.
- Strictly avoid feeding through the electrical cables so that they are directly touching pipes or parts inside the unit.
- After the first moments of operation, check the tightness of the power supply terminal screws.

Table for power supply line sizing.

Power supply	V/Ph/Hz	230/1/50
Max absorbed current	A	6.1

4.2 POSITIONING AND PROCEDURES OF THE CONNECTIONS

The unit is supplied with all electrical connections prepared and with a schuko plug for connection to the mains;

The electrical cable entry is located at the rear of the unit where two dn 16mm passages are provided;

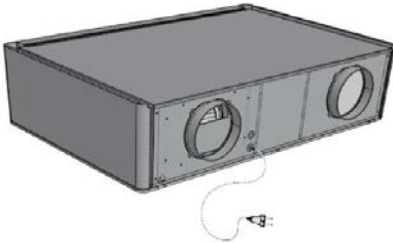

If it is not possible to carry the wiring from the rear of the unit, it is possible to exit to the right side of the unit using the pre-cut hole on the side;

In addition, in the lower part, the electrical panel can be reached through a dedicated door.

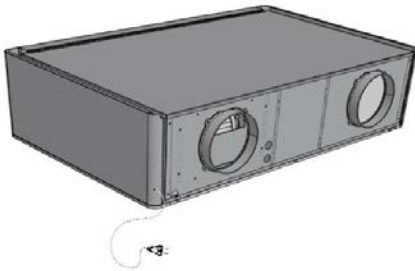

Condensate discharge connection

4.3 INSERTION OF REMOTE CONTROL BATTERIES

Only a CR2025 3 V dry lithium battery (included in the scope of supply) may be used for the remote control. Spent batteries may only be disposed of at collection points set up by Local Authorities for this type of waste. To insert the battery, open the snap-on battery door at the bottom of the remote control. The battery must be inserted carefully observing polarity. Close the snap-on door once the battery is inserted.



5 COMMISSIONING AND METHOD OF USE

5.1 OPERATION OF ON-BOARD CONTROL PANEL AND REMOTE CONTROL

The unit is controlled via the supplied infrared remote control.

The display normally shows the operating status (see paragraph Description of operation) and any alarms (see paragraph Display alarms). In addition, the various functions can be selected by pressing the various symbols. By pressing the keys it is possible to set the various functions (see paragraph Description of operation). The remote control supplied with the appliance has been designed to be extremely sturdy and functional, but must be handled with care.

Avoid:

- leaving it exposed to rain, spill liquids on its keyboard or drop it in water;
- subjecting it to heavy impacts or dropping it on hard surfaces;
- leaving it exposed to sunlight;

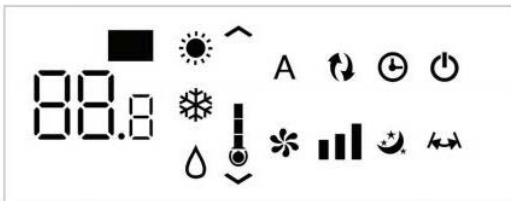

Machine panel

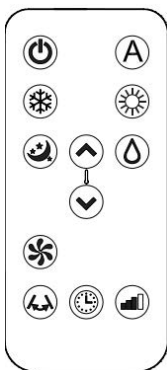

Remote control

- 1 Remote control button
- 2 Touch-screen display button

KEY / DISPLAY

- 88.8 Setpoint
- ^ Up button
- v Down button
- Power On/Off button
- A Wellness button (economic automatic operation)
- Snowflake Cooling-only operation button
- Water drop Dehumidification-only operation button
- Fan Ventilation-only operation button
- Sun Heating-only operation button (1)
- Sun Heating-only operation button (2)
- Moon Night wellness button
- Bar chart Fan speed control button
- Clock Timer function setting button (1)
- Clock Timer function setting button (2)
- Circle Brightness sensor
- Thermometer Digital thermometer; 1-7 red bars in winter, blue in summer

SWITCHING THE UNIT ON AND OFF

In order to operate the appliance using the remote control or the touch screen display, it is necessary to either switch on the main switch which has been provided on the power supply line (the technician who installed the appliance will be able to be more precise about its position), or insert the appliance's power plug into the system's socket. Once the described operations have been carried out, by prolonged pressure (3 seconds) on the symbols on the touch screen display, or with the remote control, it is possible to manage the system. In order to transmit commands to the indoor unit, the front of the remote control must be turned towards the display of the indoor unit. Receipt of the command is confirmed by the buzzer sounding a note and being shown on the display. The maximum distance at which commands can be received is approximately 8 metres.

Using the stand-by button, you can switch the appliance off or on. The appliance's control system has a memory, which means that all settings will not be lost either when the appliance is switched off or in the event of a power failure. This button is used to activate and deactivate the device for short periods.

In the event of prolonged standstill of the appliance, it must be switched off by disconnecting the main switch or removing the plug from the socket.



Unit On / Off

TEMPERATURE SET MODIFICATION

On the display there are buttons for selecting the desired temperature of the unit; Whenever the set temperature is changed, the display will also show the change in set point required.



Temperature set modification

FAN SPEED MODIFICATION

By pressing this button sequentially, the power supplied by the appliance can be set to 5 settings: Minimum, Medium, Maximum, Dual Power and Automatic.

The higher the power setting, the greater the output of the appliance, but the quieter it is.

The Dual Power function (visible by the flashing of the 3 speed bars on the display and the scrolling of the 7 bars, red or blue, on the digital thermometer), available only in heating and cooling mode, provides an overboost for 30 minutes.

The controller then inhibits the function and switches to automatic operation.

By setting the Automatic choice (visible through the scrolling of the 3 speed bars on the display) the on-board microprocessor automatically adjusts the power, keeping it higher the greater the difference between the room temperature and the set temperature. In dehumidification only and night wellness mode, power control is not possible as the appliance can only be operated at minimum power.



Fan speed management

AUTOMATIC FUNCTION

By setting this function, the appliance sets itself up so as to achieve optimal comfort in the air-conditioned room. Depending on the set temperature, the air conditioner automatically selects the operating mode (cooling, or heating), and the ventilation speed according to the room temperature and the detected air quality.



AUTO function

VENTILATION-ONLY FUNCTION

When this function is activated, the compressor is never switched on and the appliance has no effect on either the temperature or the humidity of the air in the room. It is possible to select the fan speed.



Ventilation only

NIGHT WELLNESS FUNCTION

With the appliance switched on and the cooling or heating mode selected, pressing the button allows multiple functions to be performed to maximise the quietness of the appliance, save electricity and regulate night wellness.

In this mode, fan operation is set to minimum speed.

This function should be activated immediately before falling asleep.

- In cooling mode, the set temperature set is increased by 1 °C after one hour and by a further 1 °C after 2 hours. After the second hour, the temperature set is not altered any further and after a further 6 hours the appliance is placed in stand-by.
- In heating mode, the set temperature is reduced by 1 °C after one hour and by a further 1 °C after 2 hours.

After the second hour, the temperature set is not altered any further and after a further 6 hours the appliance is placed in stand-by.

This function is not available for dehumidification-only, ventilation-only and economic automatic operation and can be overridden at any time (ideally when waking up) by pressing the button again.

If the timer function is set at the same time, the device will switch off after the set time has elapsed.



Night wellness

DEHUMIDIFICATION FUNCTION

Using this mode, the appliance dehumidifies the room. Activating this function is therefore particularly useful in the mid-seasons, i.e. on days (such as rainy days) when the temperature is pleasant, but the excessive humidity makes you feel a certain sense of discomfort. In this mode, both the room temperature setting and the fan speed setting are ignored and always correspond to the minimum. In this mode it is normal for the appliance to operate intermittently.



Dehumidification

CHANGE OF SEASON

The change of season must be carried out from the keyboard;

Press and hold the season change button for at least 3 seconds to change the season status;

This operation must be carried out in order to activate the correct logics.



Change of Season

Symbol logic: SUN = WINTER SNOWFLAKE = SUMMER

TIMER FUNCTION

The logic of the device provides the user with the possibility of programming its activation or deactivation, as desired.

While the air conditioner is switched on, it is possible to program it to switch off by pressing the Timer button, followed by setting the number of hours (from 1 to 24) after which the appliance will be placed in stand-by mode.

When the air conditioner is off, it is possible to pre-set it to turn on by pressing the Timer button, followed by setting the number of hours (1 to 24) after which the unit will start up.

Subsequent pressing of the key for confirmation.



5.2 AIR QUALITY SENSOR OPERATION

The unit provides for the operation of the fans according to the selected speed and the internal logic linked to the air quality value detected; for each speed, if the air quality is not optimal, the fans increase the flow rates in order to have a greater exchange of air and improve the indoor air quality.



5.3 UVC LAMP OPERATION (AP20384)

The unit operates a germicidal UVC lamp (AP20384 accessory) in the fresh air inlet section; The lamp is permanently activated together with the activation of the fans.





6 MAINTENANCE

To always guarantee correct and optimal unit operation, it is necessary to periodically perform all of the maintenance activities.

6.1 EPM1 FILTER CLEANING OR REPLACEMENT

To replace the filters, or periodically clean them, do the following:

- cut off the power to the unit;
- Remove the front grille;
- Remove the 2 dirty filters by sliding them downwards;
- Gently insert the new ones;
- Close the front grille;

If the conditions of the filters allow it, it is possible to proceed with cleaning them using a vacuum cleaner or low pressure compressor.

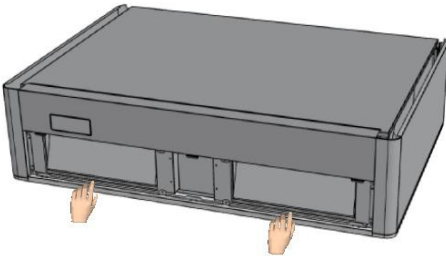

6.2 PRE-FILTER REPLACEMENT

To clean the outside air prefilter, proceed as follows:

- cut off the power to the unit;
- Remove the front grille;
- Remove the bottom panel through the front screws and out of the rear seats;
- Remove the inspection door using the dedicated screws;
- Remove the filter;

If the conditions of the filters allow it, it is possible to proceed with cleaning them using a vacuum cleaner or low pressure compressor.

- Close the filter cover ensuring that all screws are tightened;
- Replace the bottom panel in the slots and insert the screws in the front;
- Replace the grille in its place;

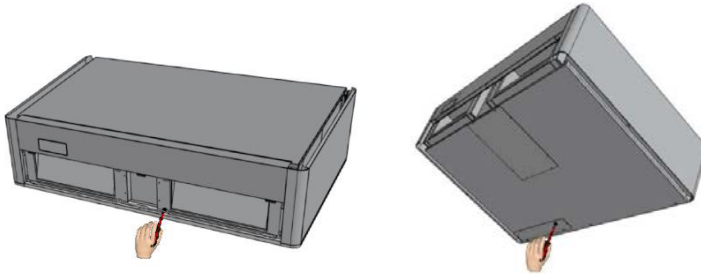

6.3 UVC LAMP MAINTENANCE (AP20384)

To service the UVC lamp (AP20384 accessory):

- Cut off the power supply to the unit;
- Remove the front grille;
- Remove the intake air filter to access the UVC lamp;
- The UVC lamp will be clearly visible behind the filter;
- Remove the lamp from the holder and the connector, taking care to pull it out gently;
- Replace and relocate the new lamp;
- Reinsert the filter into the filter housing;
- Finally, position the front grille,



ATTENTION

Never carry out such operations with the lamp and unit powered;
UVC radiation can cause damage to the skin and eyes;

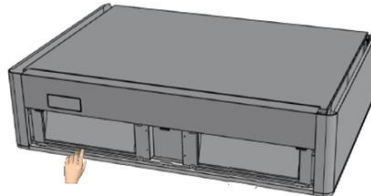
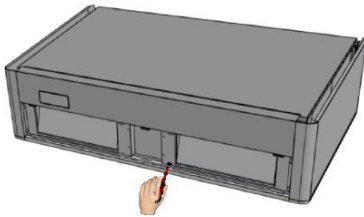

7 ALARMS

In case of any problems or failures, take note of any error code appearing on the remote control screen, take note of the model and the serial number of the unit you possess (data provided on the identification plate attached on the side of the unit) and contact the installer.

7.1 PROBLEMS WITHOUT ANY INDICATION OF THE ERROR ON THE DISPLAY

PROBLEM	CAUSES	SOLUTIONS
Display off	No power supply (luminous switch off)	Check the connection to the electrical mains.
		Check and if necessary replace the fuse on the power supply connector (black) on the side of the unit.
Poor or no air flow rate The rooms remain humid	Clogged filters	Change the filters.
	Clogged exchanger	Clean the exchanger.
	Frozen exchanger	Take the exchanger to a warm place and wait for it to defrost, do not heat with direct sources of heat.
	Dirty fan	Clean the fan.
	Clogged fan ducts	Clean the fan ducts.
	Outdoor temperature below 0 °C	The unit might be in anti-freeze mode, wait until the outdoor temperature rises or install an electric heater for pre-heating.
High noise level	Noise generated by the unit	Check for cracks and/or air leaks from the unit panels.
		Check the trap connection
		Check whether the motors are spinning correctly (bearings).
	Noise coming from the ducts	Check for cracks on the suction / supply / exhaust ducts.

High vibrations	Vibrating panels	Check the integrity of the unit panels and profiles.
		Check the correct closing of the unit cover and the panel that covers the electronic board.
		Make sure there are no walls that can transmit vibrations to the wall / floor / false ceilings.
	Imbalanced fan blades	Check the integrity of the blades.
		Clean the fans.
		Make sure the small metal blade balancing clips are still on the fans.
Condensation leak	Clogged condensation discharge	Clean the condensate discharge.
	The condensation does not flow from the discharge duct to the collection tray	Make sure that the unit is perfectly level.
		Check that the condensation discharge connections are not clogged.
The appliance does not switch on	No power supply	Check whether there is voltage in the mains (by switching on a light bulb in the house, for example).
		Check that the exclusive thermomagnetic switch protecting the appliance has not tripped (if so, reset it). If the problem recurs, contact the Service Department immediately and do not attempt to operate the appliance.
The appliance does not cool/heat sufficiently	Set temperature too high or too low	Check and correct the temperature setting if necessary.
	The air filter is clogged	Check the air filter and clean it if necessary.
	Check that there are no obstructions to the flow of air inside or outside.	Remove anything that might obstruct airflow.

7.2 TABLE OF ALARMS REPORTED ON THE DISPLAY

ALARM	CAUSE	OPERATION
E1	Room temperature probe RT faulty	The Cooling, Dehumidification and Heating functions can be activated regularly. The control only monitors the internal battery antifreeze.
E2	IPT internal battery probe faulty	The Cooling, Dehumidification and Heating functions can be activated regularly.
E3	Faulty OT outdoor air temperature probe	The Cooling, Dehumidification and Heating functions can be activated regularly.
E4	Faulty OPT external battery probe	The Cooling, Dehumidification and Heating functions can be activated regularly. The control runs defrosting cycles at fixed times.
E5	Faulty internal fan motor	No operation of the device can be activated.
E6	Faulty external motor fan	No operation of the device can be activated.
E7	Lack of communication with the display	No operation of the device can be activated.
E8	Compressor discharge probe fault	No operation of the device can be activated.
CP	CP Presence contact open	The device is only activated when the contact is closed. Check the connection of the terminals.

FANTINI COSMI S.p.A.

Via Dell'Osio, 6 - 20049 Calepio di Settala, Milan, Italy
Tel. +39 02 956821 | Fax +39 02 95307006
E-mail: info@aspira.it | supportotecnico@aspira.it