



## INSTRUCTIONS FOR USE

# CH193VMC

## CENTRALISED CONTROL FOR VMC UNITS

Code: AP 20047  
AP 20048  
AP 20050  
AP 20052  
AP 20054  
AP 20056  
AP 20058



**FANTINI COSMI S.p.A.**

Via dell'Osio, 6 20049 Caleppio di Settala, Milan – ITALY  
Tel. +39 02 956821 | Fax +39 02 95307006 | info@fantinicosmi.it  
www.fantinicosmi.it

Thank you for purchasing a **FANTINI COSMI S.p.A.** product.

Please read this instruction manual carefully and always keep it at hand should you need to consult it for any reason.

The documentation reflects the characteristics of the product. However, for regulatory or commercial developments, customers should verify the availability of updates relating to this documentation on the FANTINI COSMI S.p.A. website: [pdf.fantincosmi.it](http://pdf.fantincosmi.it)

## OPERATION

CH193VMC is an LCD remote panel for the advanced control of ventilation systems through VMC. Equipped with temperature, relative humidity and VOC sensors, it automatically controls ventilation and indoor air quality (IAQ).

### Note:

The CH193VMC has been designed to work with different machines.

When switching on for the first time, as already indicated in the manual, the machine to which the device is to be connected must be chosen.

## CONTENTS OF PACKAGE

- 1 VMC control panel
- 2 6/32UNC American standard thread screws to secure onto 503 recessed box (approximately Ø 3.5mm)
- 1 quick guide
- 1 cable (cod. 1598122) to be used with the EXT IN input set to DH/IN for an external dehumidification and integration request. (Can be used on AP 20060-AP 20062 machines).

## DESCRIPTION OF DISPLAY KEYS

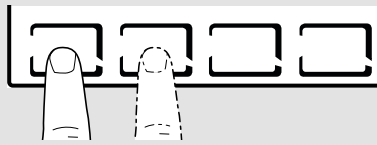

The first time any touch key is pressed, this activates the functions of the buttons themselves and lights up the display.

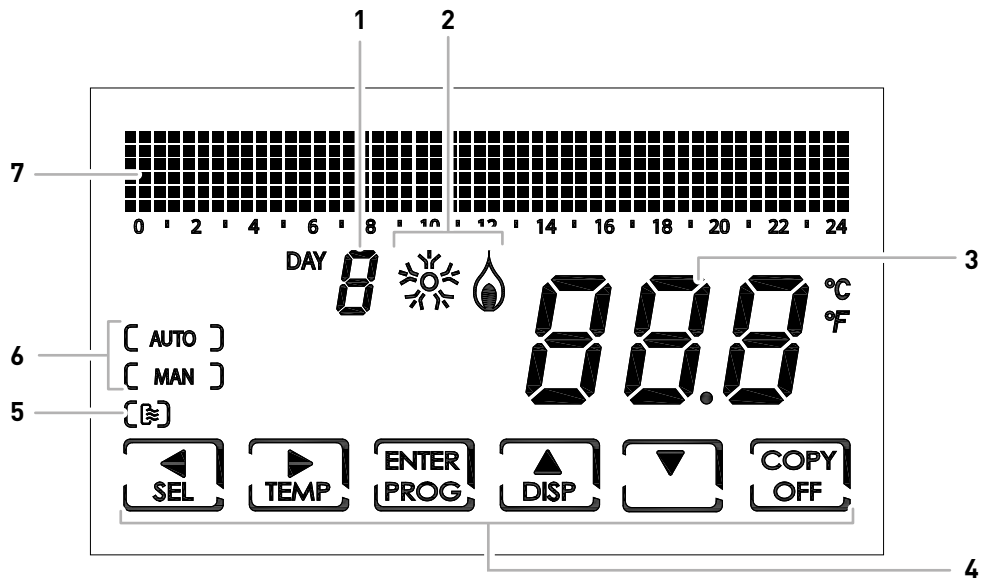

- |   |   |
|---|---|
| 1 | Day of the week   |
| 2 | Heating/cooling coil activation state (if the VMC is set up for this) |
| 3 | Room temperature (Celsius/Fahrenheit) detected                        |
| 4 | Multi-function touch icons  |
| 5 | VMC ventilation status  |
| 6 | Operating mode  |
| 7 | Bar graph to display messages and daily programming                   |

**Please note:** the function of the multi-function keys varies depending on the situation and is described by the symbol that appears on the display next to the key.

## TECHNICAL FEATURES

Rated power supply voltage	9 - 24 Vcc
Absorbed current	150 mA Max
Backlight switch-off	60s after last touch
Temperature regulation scale	5 ÷ 35 °C, increase 0.1°C
Measurement scale room T	- 50 to + 50 °C, resolution 0.1°C
Relative humidity adjustment scale	30 ÷ 70 % resolution 1%
Room relative humidity display scale	0 ÷ 100 % increase 1%
Air quality view	via VOC sensor
Communication interface	RS485
Communication mode	ModBus RTU (master)
Data formats	9600 bps 8 bits no parity 1 bit stop
Maximum room temperature	45°C
Storage temperature	-10°C ÷ +60°C
Rated pulse voltage	4000V
Software	Class A
Insulation class	Class II 
Protection rating	IP30
Degree of pollution	2
Number of operating cycles for manual actions	3000
Number of operating cycles for automatic actions	10000
Type of installation	wall-mounted or on flush mounting box
Dimensions	127 x 82 x 14 mm
Weight	0.100 Kg
Compliant with	<ul style="list-style-type: none"> <li>■ EN 60730-1 and second parts</li> <li>■ Directive 2014/30/EU (EMC)</li> <li>■ Directive 2014/35/EU (LVD)</li> </ul>
ErP classification	<ul style="list-style-type: none"> <li>■ ErP Class IV; 2% [Reg. EU 811/2013 - 813/2013]</li> </ul>

Product made in Italy

## Contents

<b>OPERATION</b> .....	<b>2</b>	6.9 - RH (RELATIVE HUMIDITY PROBE DISPLAY) .....	22
<b>CONTENTS OF PACKAGE</b> .....	<b>2</b>	6.10 - IAQ (AIR QUALITY PROBE DISPLAY).....	23
<b>DESCRIPTION OF DISPLAY KEYS</b> .....	<b>3</b>	6.11 - DEW P (DISPLAY OF THE DEW POINT) .....	23
<b>TECHNICAL FEATURES</b> .....	<b>4</b>	6.12 - HOURS OF USE.....	24
<b>1 - INSTALLATION</b> .....	<b>6</b>	<b>7 - ADVANCED FUNCTIONS (PROG)</b> .....	<b>25</b>
<b>2 - ELECTRICAL CONNECTION</b> .....	<b>8</b>	7.1 - SWITCHING ON DISPLAY.....	25
2.1 - VMC SIDE CONNECTION .....	9	7.2 - DISPLAY LIGHTING INTENSITY.....	25
2.2 - CONNECTION FOR INTEGRATION AND DEHUMIDIFICATION THROUGH THE "EXT IN" INPUT WITH EXTERNAL CABLE (cod. 1598122) ..	9	7.3 - DAYLIGHT SAVING / STANDARD TIME .....	26
2.3 - START-UP .....	9	7.4 - VMC/ EXT HEAT.....	26
<b>3 - USER FUNCTIONS (PROG)</b> .....	<b>10</b>	7.5 - VENTILATION .....	27
3.1 - DATE AND TIME SETTING .....	10	7.5.1 - V1.....	27
3.2 - WINTER/SUMMER SETTING .....	11	7.5.2 - V3.....	28
3.3 - PROGRAMMING SETTING VMC PROFILE .....	11	7.5.3 - BOOST .....	28
3.4 - SETTING MACHINE OPERATION IN INTEGRATION .....	12	7.5.4 - INT.....	29
3.5 - Vmc PANEL DISPLAY SETTINGS .....	14	7.6 - INTEGRATION (THIS FUNCTION IS ONLY VISIBLE WHEN EXT HEAT IS ACTIVE) .....	30
3.6 - SETTING KEYBOARD LOCK WITH PASSWORD .....	15	7.6.1 - MINIMUM TEMPERATURE .....	30
<b>4 - OPERATING PROGRAMS (SEL)</b> .....	<b>16</b>	7.6.2 - MAXIMUM TEMPERATURE .....	31
4.1 - SELECTING THE OPERATING PROGRAM.....	17	7.6.3 - DIFFERENTIAL MANAGEMENT .....	31
<b>5 - OPERATION (TEMP)</b> .....	<b>18</b>	7.6.4 - ANTIFREEZE TEMPERATURE .....	32
5.1 - VMC (DISPLAYED ONLY WITH INTEGRATION SWITCHED OFF)...	18	7.7 - ROOM TEMPERATURE CORRECTION .....	32
5.2 - T MAN (CAN BE DISPLAYED WITH THE INTEGRATION FUNCTION ACTIVE AND THE TEMPERATURE SET POINT IN MANUAL).....	18	7.8 - CELSIUS / FAHRENHEIT .....	33
5.3 - T ECO / T COMF (CAN BE DISPLAYED WITH INTEGRATION FUNCTION ACTIVE AND SETTING THE TEMPERATURE SET POINT IN AUTOMATIC MODE) 19	19	7.9 - BY PASS (ONLY AVAILABLE WITH SUMMER FUNCTION) ....	33
<b>6 - PARAMETER DISPLAY (DISP)</b> .....	<b>20</b>	7.10 - SENS .....	34
6.1 - DATE AND TIME .....	20	7.10.1 - RH.....	34
6.2 - SEASON .....	20	7.10.2 - VOC .....	35
6.3 - VMC PROFILE (THE PROFILE ACCORDING TO THE PREVIOUS SETTINGS IS DISPLAYED).....	20	7.11 - FILT .....	36
6.4 - INTEGRATION (ONLY AVAILABLE WITH THE INTEGRATION FUNCTION ACTIVE).....	21	7.12 - LANGUAGE SELECTION .....	36
6.5 - AIR (RETURN AIR TEMPERATURE PROBE INSIDE THE VMC) ..	21	7.13 - ALARMS .....	37
6.6 - H2 (EXHAUST AIR TEMPERATURE PROBE INSIDE THE VMC) ..	21	7.14 - CHG .....	38
6.7 - H4 (OUTDOOR AIR INTAKE PROBE POSITIONED INSIDE THE VMC) .....	22	7.15 - EXT IN .....	38
6.8 - EXT (USED INPUT DISPLAY).....	22	7.16 - SOUND ALARM.....	39
		7.17 - BEEP .....	39
		7.18 - LED .....	40
		7.19 - INFORMATION .....	40
		7.20 - RESETTING DEFAULT PARAMETERS.....	41
		<b>8 - DISPOSAL</b> .....	<b>42</b>
		<b>9 - GENERAL WARRANTY CONDITIONS</b> .....	<b>42</b>

## 1 - INSTALLATION



**ATTENTION!**

Installation must be carried out by qualified personnel in compliance with the requirements concerning the installation of electrical equipment.



**ATTENTION!**

Installation operations must be performed with the system's power disconnected.

CH193VMC must be installed on the wall or on a flush mounting box, in 3 units, at a height of about 1.5m from the floor, in a suitable position to detect the room temperature correctly.

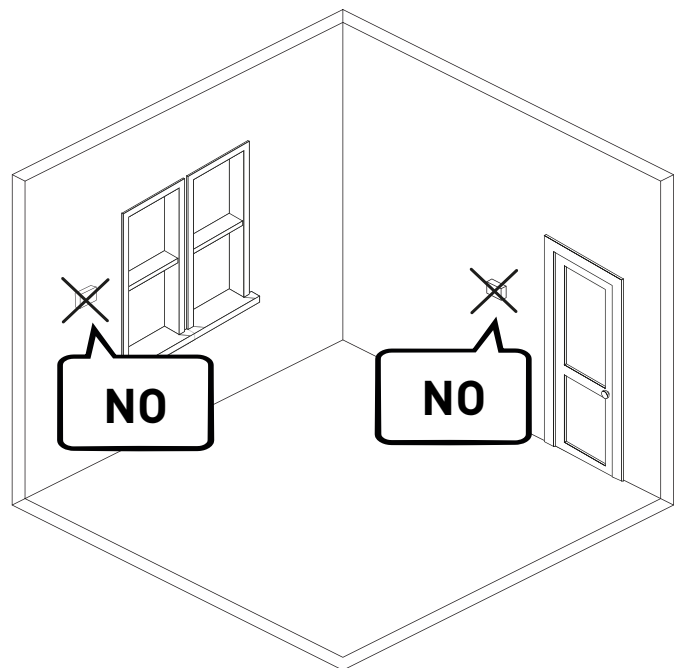
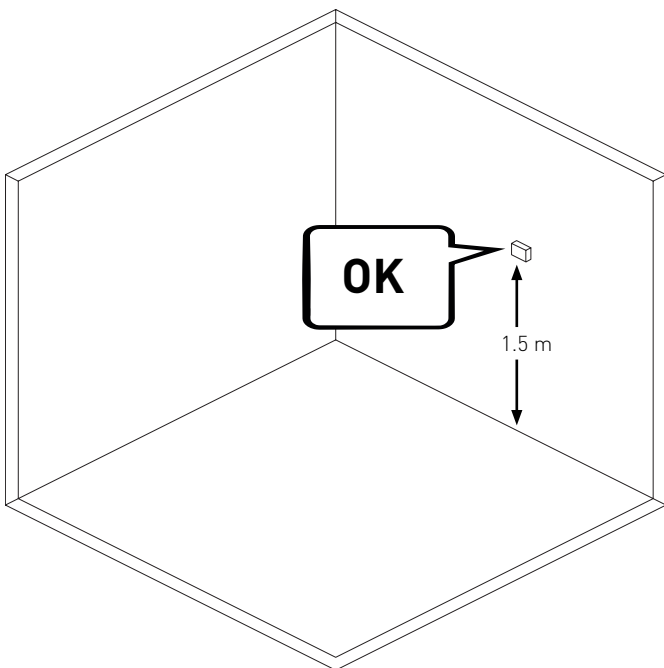
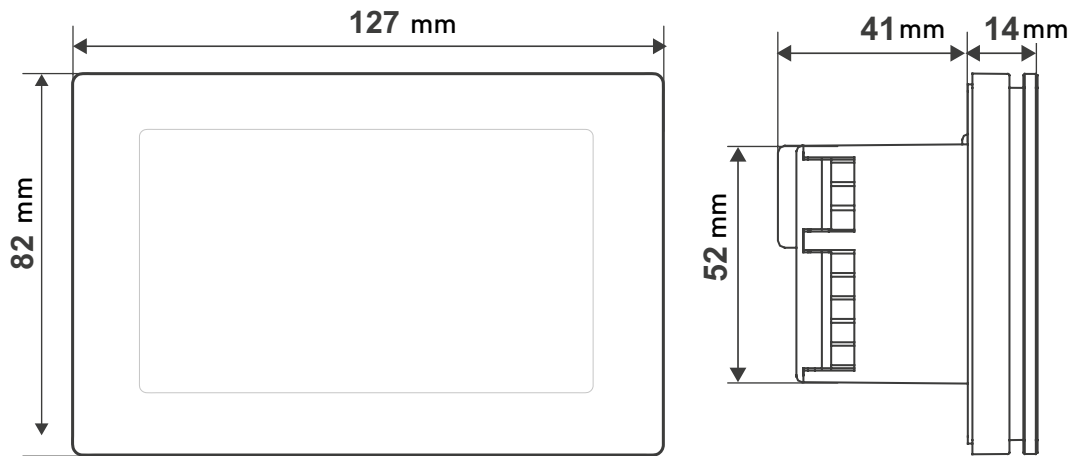

Place the rear body in the wall box.

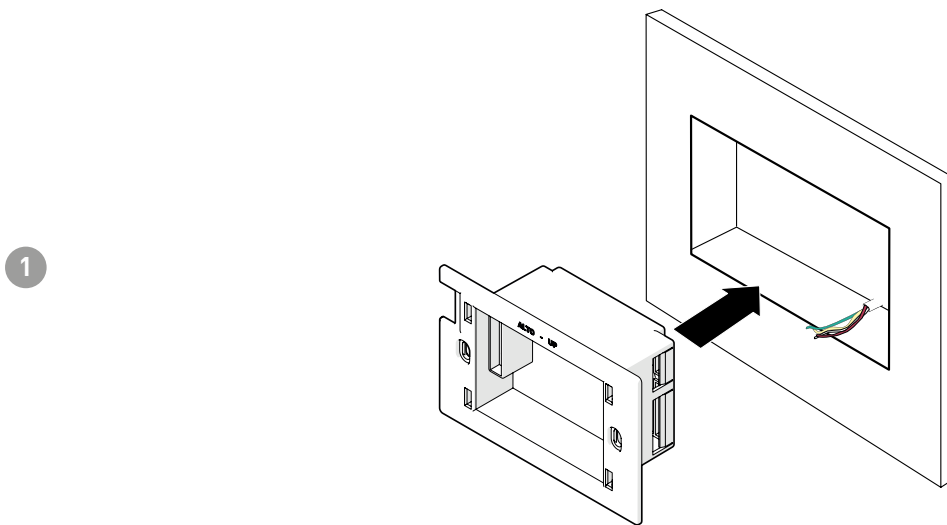

Make the electrical connections (refer to “2 - ELECTRICAL CONNECTION”) and secure the rear body to the wall with the screws provided.

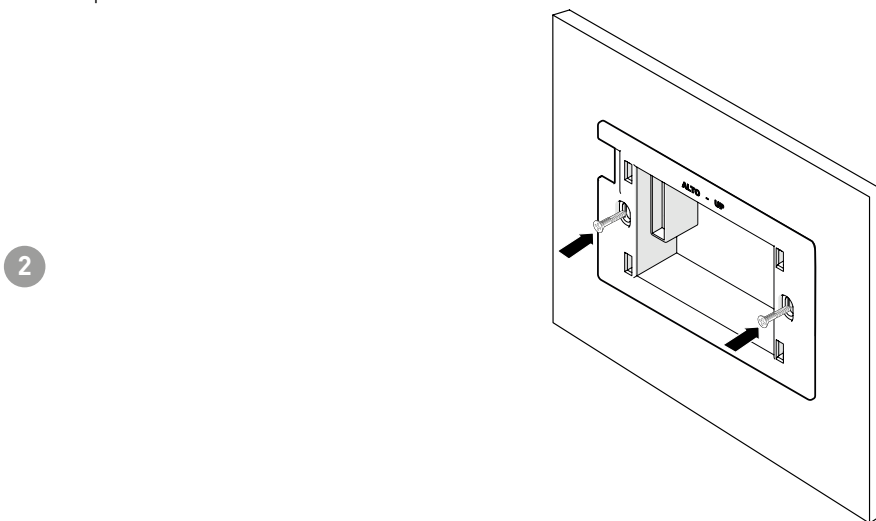

Hook the front of the control unit onto the rear wall body.

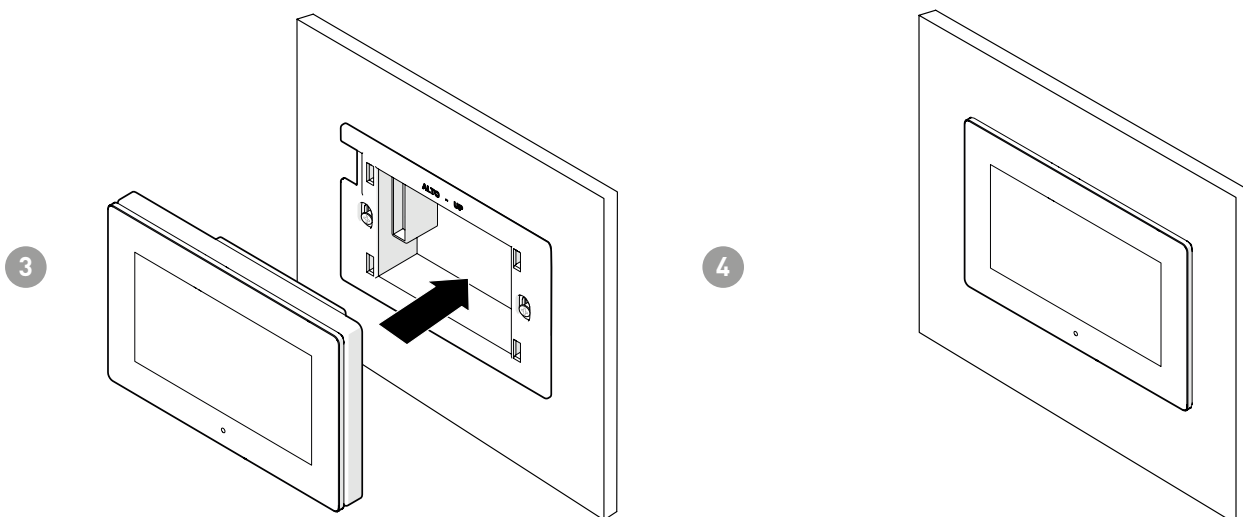

## 2 - ELECTRICAL CONNECTION



**ATTENTION!**

Electrical connections must be made by qualified personnel.



**ATTENTION!**

Electrical connection operations must be done with the system's power disconnected.

CH193VMC is connected directly to the Fantini Cosmi VMC machines. The connection changes based on the VMC code.

**Note: For the correct installation of the CH193VMC / CH193BVMC panel:**

1. Verify that power and data cables A and B are properly connected.
2. Data input A and B is polarized, make sure they are not reversed.
3. To avoid any electromagnetic disturbances, separate the signal conductors (A, B, Vcc, GND and those for integration) from the power ones using separate corrugated tubes at a distance of about 1.5m from each other.
4. Use shielded and twisted cables, and ground them on the CH193VMC side.

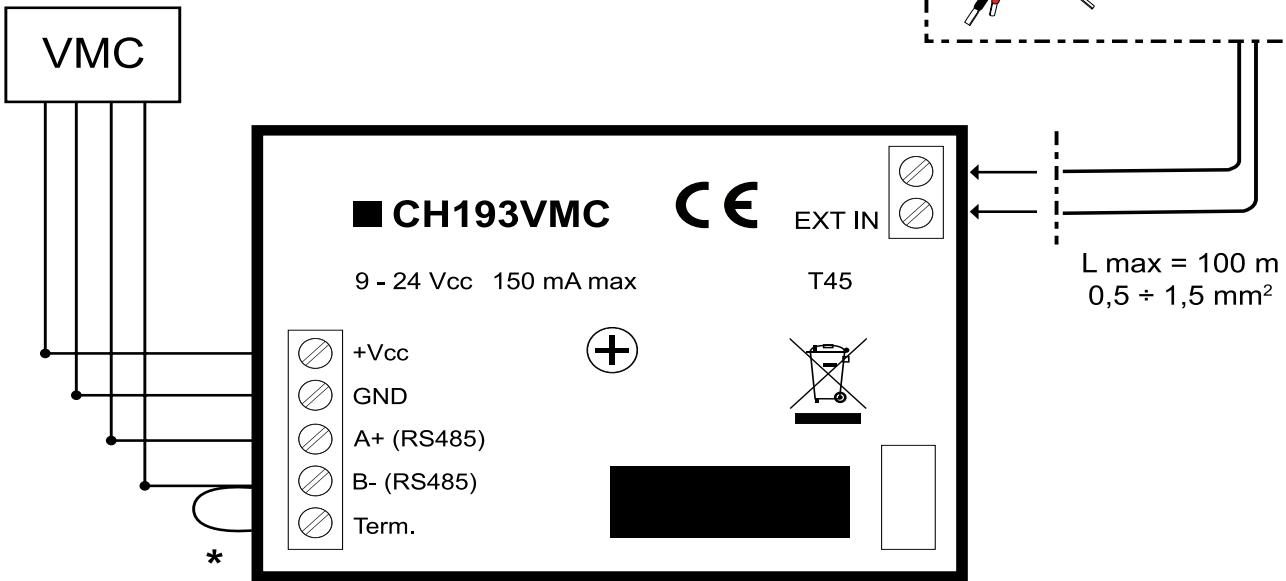
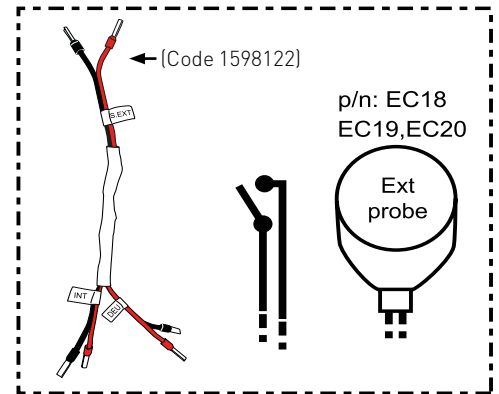

**\*Note:** Jump the terminals.  
Use a shielded cable and ground it on the CH193VMC side.

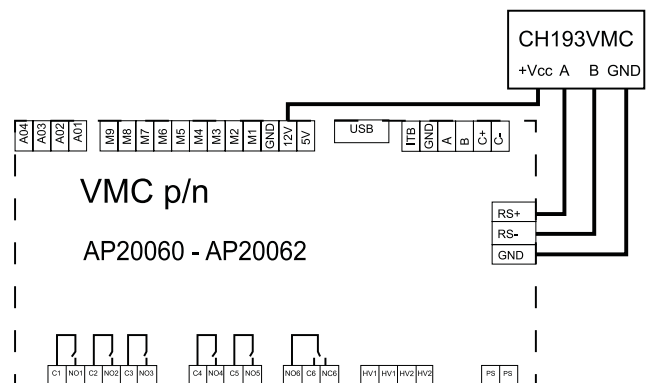
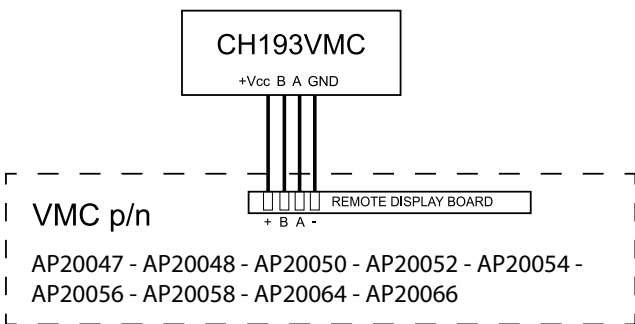



## 1.1 - VMC SIDE CONNECTION

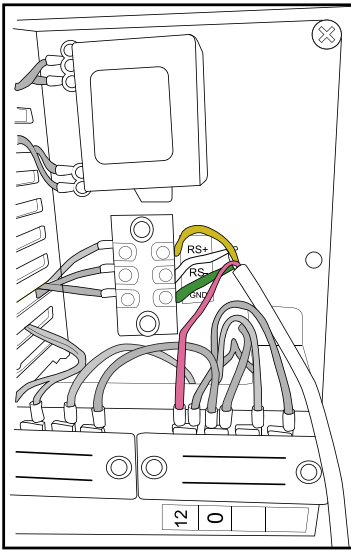

AP20060 - AP20062

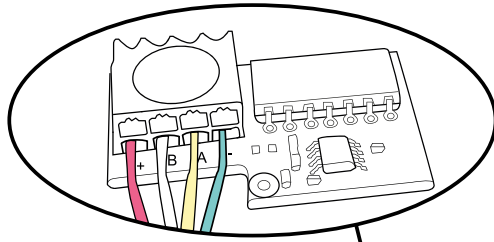

AP20047 - AP20048  
 AP20050 - AP20052  
 AP20054 - AP20056  
 AP20058 - AP 20064  
 AP20066

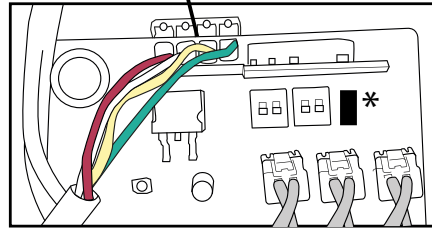

\* Ensure that the jumper is correctly inserted

## 1.1 - CONNECTION FOR INTEGRATION AND DEHUMIDIFICATION THROUGH THE "EXT IN" INPUT WITH EXTERNAL CABLE (cod. 1598122)

The cable cod. 1598122 can be used with AP 20060 and AP 20062 when there is an external demand for dehumidification and/or heating/cooling integration.

For all other machines, a direct connection to the EXT IN input is sufficient.

It is necessary to set from "Advanced User" the EXT IN input to DH/IN.

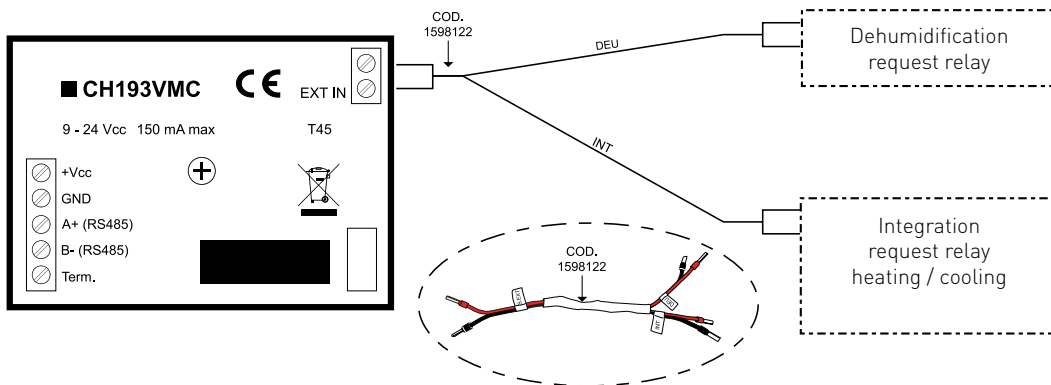

## 1.1 - START-UP

At first switch-on, the CH193VMC must be coupled to a VMC. Choose the code of the installed VMC.

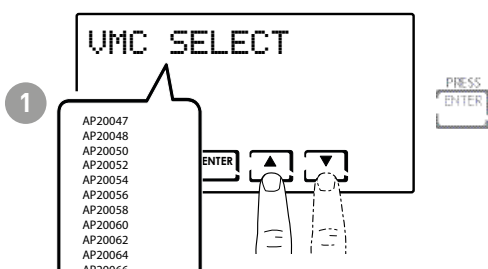

### 3 - USER FUNCTIONS (PROG)

The first time any touch key is pressed has no effect, but only activates the functions of the buttons themselves and lights up the display.

After 60 seconds of no interaction, the display goes back to the main screen.

 = allows you to CONFIRM

 = allows you to PROGRAM

**Note:** To change the settings use the UP and DOWN arrows and the RIGHT and LEFT arrows to go forward or backward.

#### 1.1 - DATE AND TIME SETTING

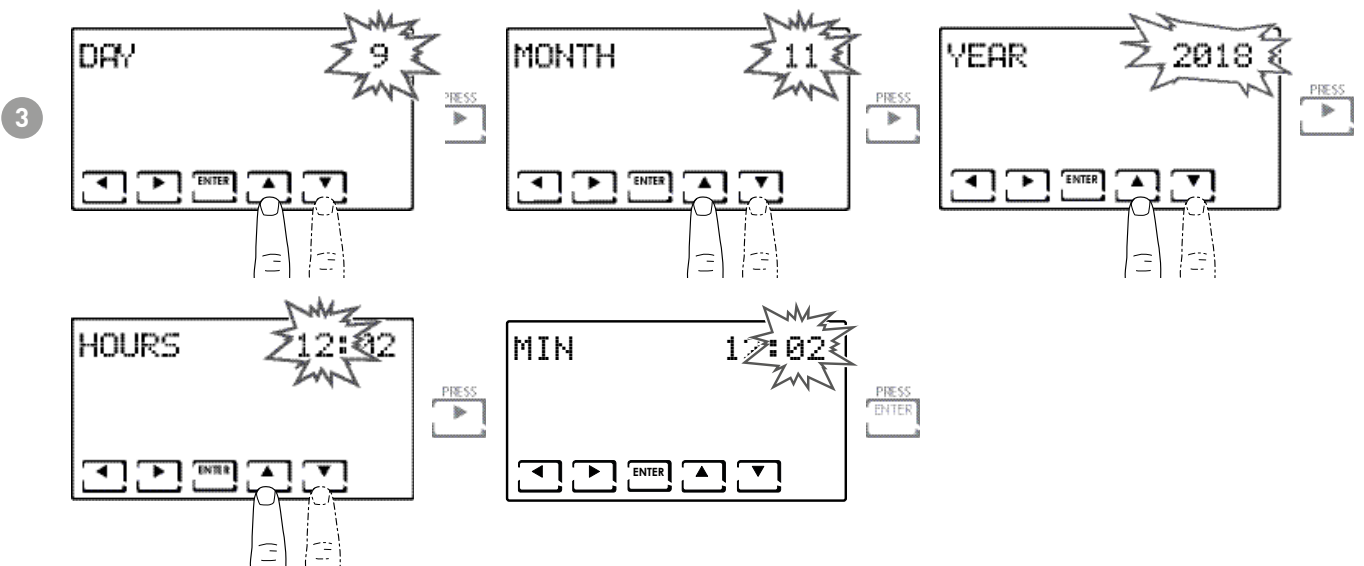
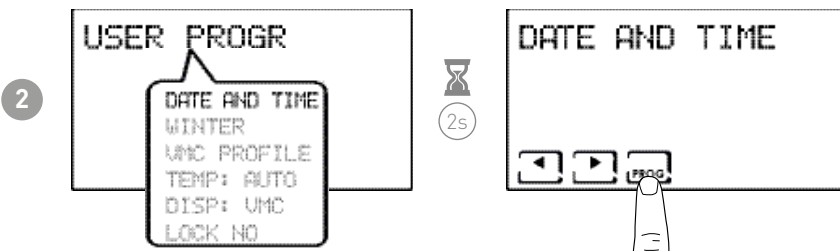
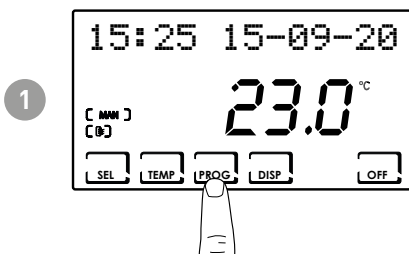

**Note:** by pressing ◀ always allows you to go back to the previous page.

## 1.1 - WINTER/SUMMER SETTING

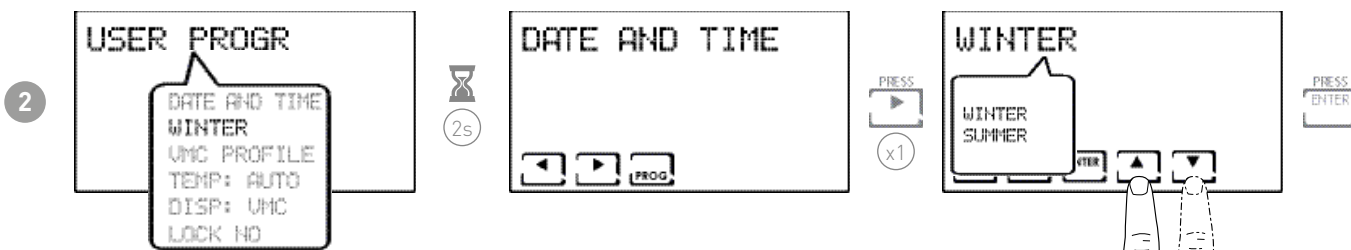
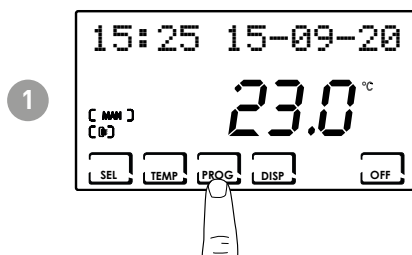

## 1.1 - PROGRAMMING SETTING VMC PROFILE

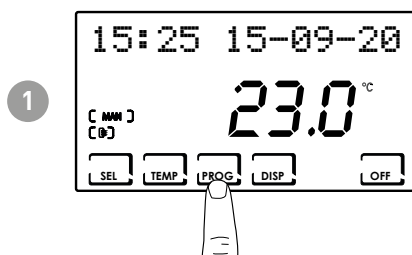

On the remote panel you can set the ventilation profiles (fan speeds) of the VMC on 7 days and different for Summer/Winter.

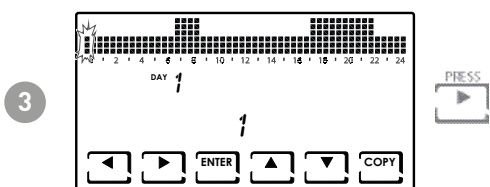

**Note:** pressing ◀ or ▶ allows you to scroll through the hours.

4

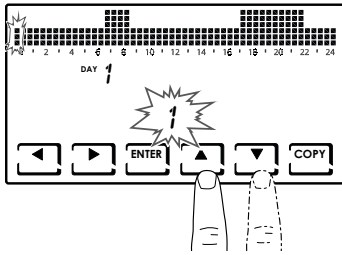

Pressing ▲ or ▼ allows you to select the VMC profile depending on the time.

**SETTABLE SPEEDS:**

- OFF
- 1 = V1
- 2 = V2
- 3 = V3

- Pressing ENTER to go to the next day.

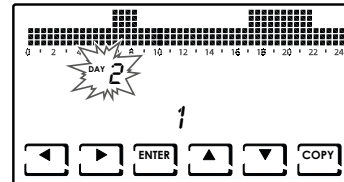
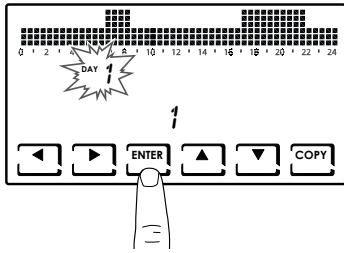

- Pressing COPY allows you to copy the temperature profile displayed to the following day.

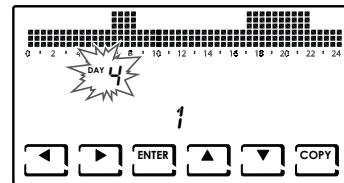
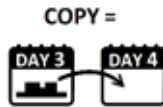
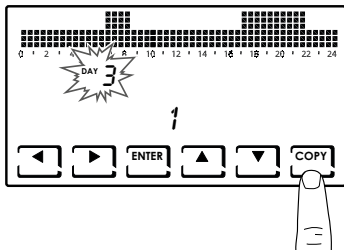

## 1.1 - SETTING MACHINE OPERATION IN INTEGRATION

**Note:** Can be set from the "Advanced Programming" menu.

1

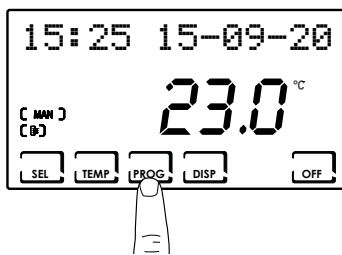

If the machine is designed to integrate heating and/or cooling, it is possible to set the temperature set point with a weekly programme (with resolution every 30 minutes) or manually.

2

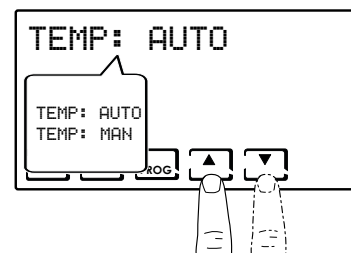
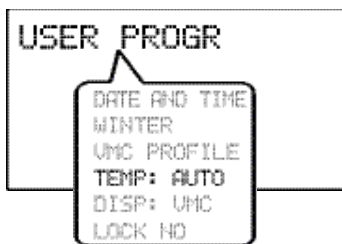

**Note:** it is possible to set the machine for manual operation (T MAN) and automatic operation (T ECO/TCOMF). When TEMP is selected: AUTO is displayed, then follow the procedure described in 3 and 4.

3

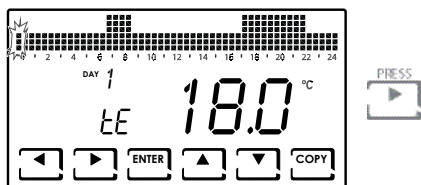

**Note:** pressing ◀ or ▶ allows you to scroll through the hours.

4

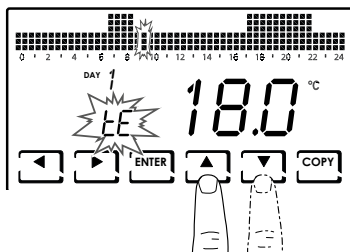

Pressing ▲ or ▼ allows you to select the profile depending on the time.

**SETTABLE PROFILES:**

- tC (comfort) = SUMMER, WINTER
- tE (economy) = SUMMER, WINTER
- tA (antifreeze) = only for WINTER
- OFF = only for SUMMER

In winter tE < tC; in summer tC < tE.

**Note:**

- Pressing ENTER to go to the next day.

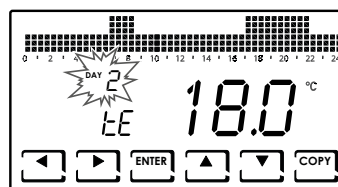
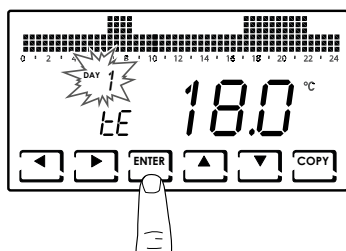

- Pressing COPY allows you to copy the temperature profile displayed to the following day.

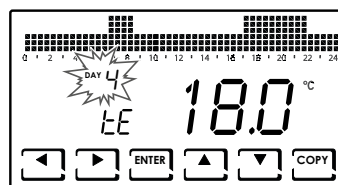
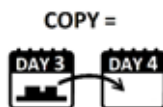
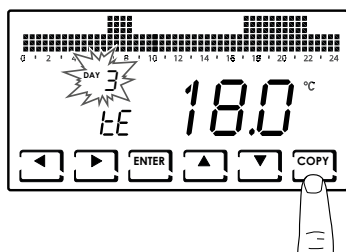

## 1.1 - VMC PANEL DISPLAY SETTINGS

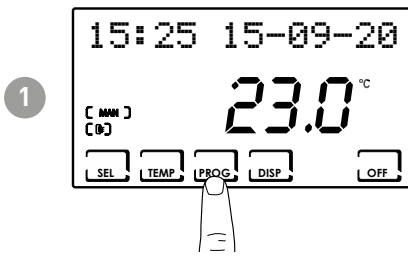

### DISPLAYS ON THE MAIN SCREEN:

3

- DISP:VMC = the set speed is displayed.
- DISP:TIME = the time is displayed.
- DISP:DEW P = DEW P (dew point) is displayed.
- DISP:IAQ = air quality is displayed.
- DISP:RH = Relative humidity is displayed.
- DISP:EXT = the input used is displayed:
  - ◇ --- = OFF
  - ◇ ALR C = ALARM CLOSED
  - ◇ ALR O = ALARM OPEN
  - ◇ INTEG = INTEGRATION

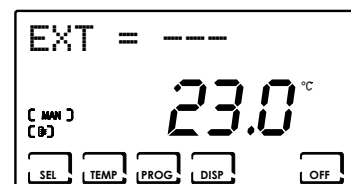
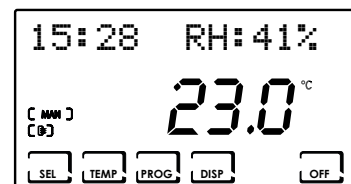
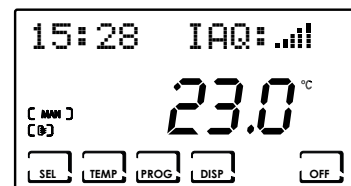
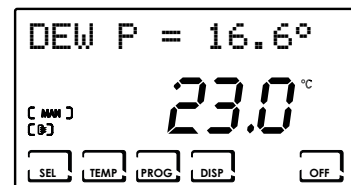
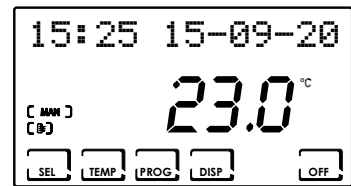
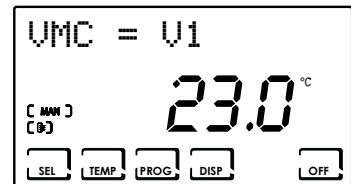

- DISP:INTEG = the time schedule of the integration is displayed.

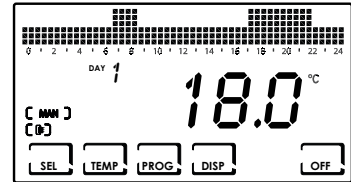

## 1.1 - SETTING KEYBOARD LOCK WITH PASSWORD

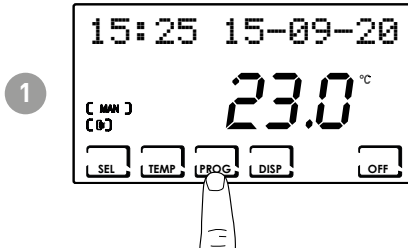

**Note:** selecting LOCK YES displays the PROG key. Then follow the procedure described in points 3 and 4.

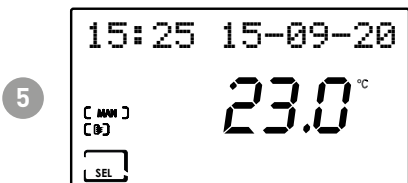
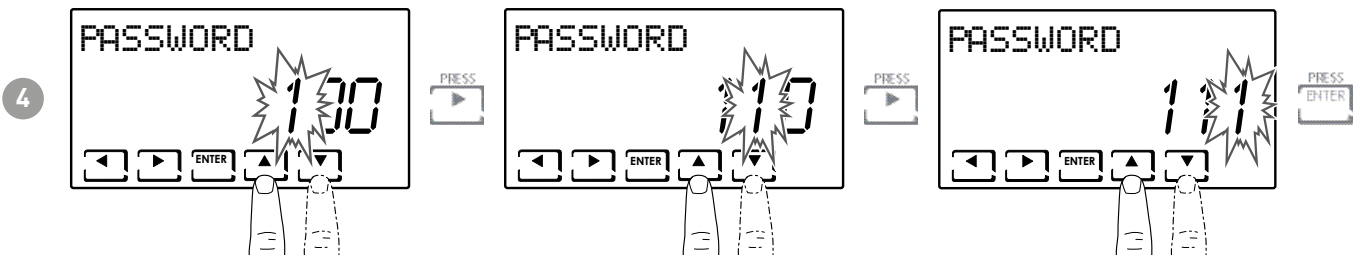
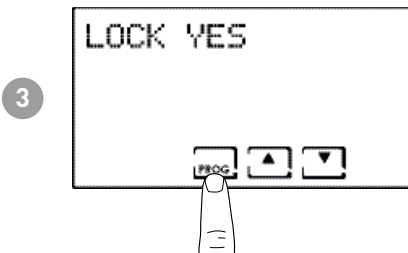

When the keyboard is locked, you can only press the SEL key.  
Pressing SEL allows you to enter the set password and unlock the keyboard.

## 4 - OPERATING PROGRAMS (SEL)

For the management of ventilation systems, CH193VMC allows different operating modes, called programmes.

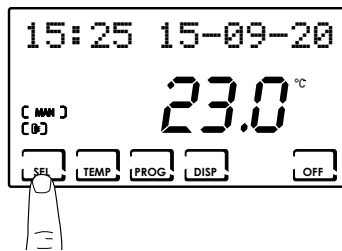

### [ MAN ]

- MANUAL PROGRAM

The device adjusts the speed (V1, V2, V3, BOOST, the latter for a limited time) specified from time to time for an unlimited time, until a new command is given.

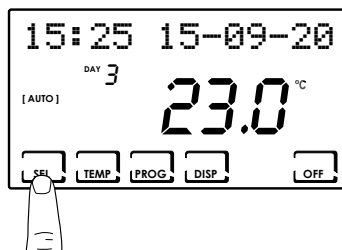

### [ AUTO ]

- WEEKLY PROGRAM

The device manages time programme settings on a weekly profile. Speeds (V1, V2, V3, OFF) can be set every half hour.

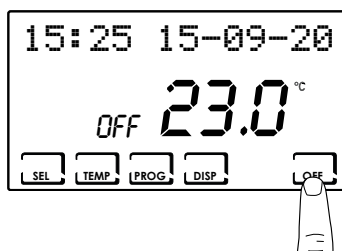

### [ OFF ]

- SYSTEM OFF

Press the OFF key to switch off the system completely.

If you press the OFF key in SYSTEM OFF mode, it goes back to the previously set operating mode.



## 1.1 - SELECTING THE OPERATING PROGRAM

The ventilation programmes of the VMC are selected in cycles.

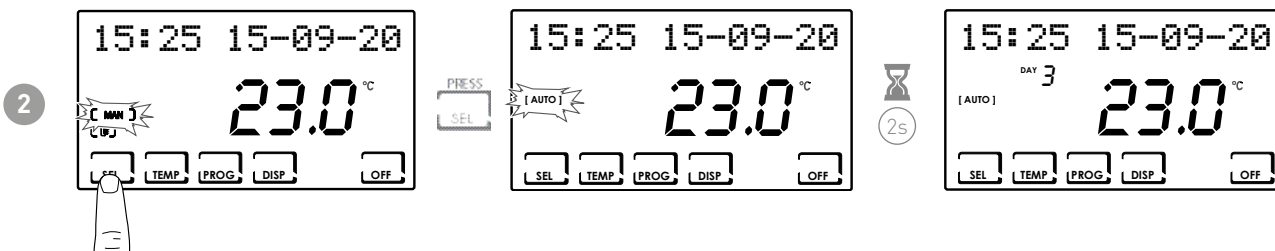
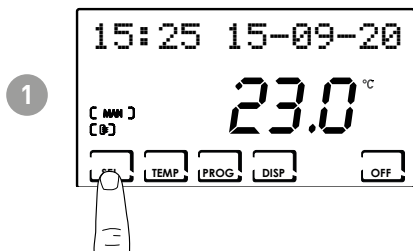

**Note:** you can select the program from: [MAN] - [AUTO].

## 5 - OPERATION (TEMP)

Can be used according to selections made previously.

### 1.1 - VMC (DISPLAYED ONLY WITH INTEGRATION SWITCHED OFF)

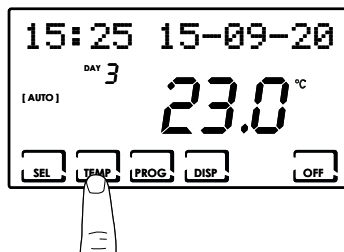

You can set the speed of the machine between:

- V1
- V2
- V3
- BOOST

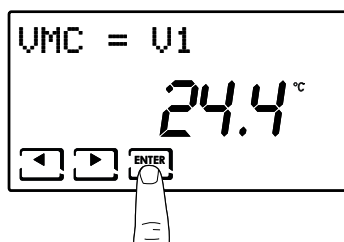

### 1.1 - T MAN (CAN BE DISPLAYED WITH THE INTEGRATION FUNCTION ACTIVE AND THE TEMPERATURE SET POINT IN MANUAL)

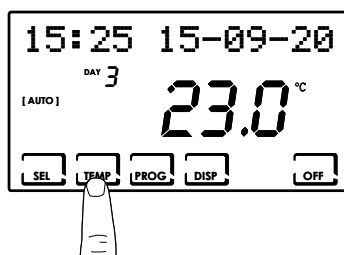

A temperature value T MAN (Manual Temperature) between 5 and 35°C can be set.

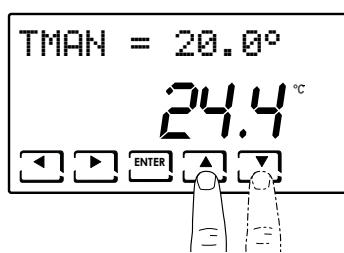

**Note:** adjustment does not depend on the room temperature read by the CH193VMC sensor but on the AIR probe inside the VMC (see paragraph “6.5 - AIR (RETURN AIR TEMPERATURE PROBE INSIDE THE VMC)”).

## 1.1 - T ECO / T COMF (CAN BE DISPLAYED WITH INTEGRATION FUNCTION ACTIVE AND SETTING THE TEMPERATURE SET POINT IN AUTOMATIC MODE)

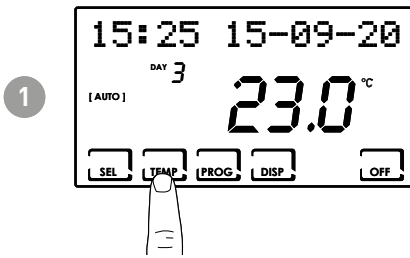

You can set a tECO (economy temperature) and tCOMF (comfort temperature) temperature value between 5° and 35°C.

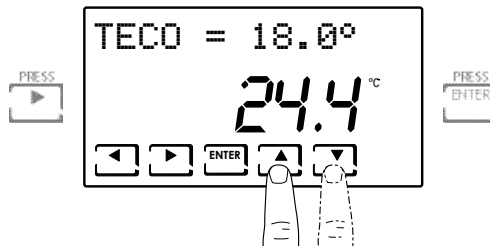
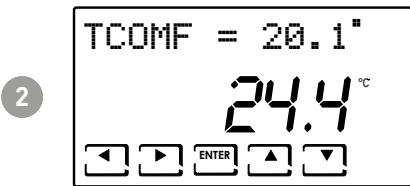



**Note:** adjustment does not depend on the room temperature read by the CH193VMC sensor but on the AIR probe inside the VMC (see paragraph “6.5 - AIR (RETURN AIR TEMPERATURE PROBE INSIDE THE VMC)”).

## 6 - PARAMETER DISPLAY (DISP)



 Pressing the DISP key allows you to display certain parameters set according to the active operating program.

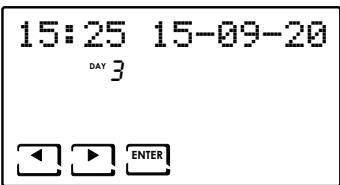

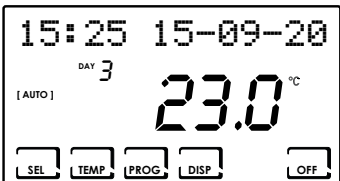

### 1.1 - DATE AND TIME

1   The date and time are displayed.

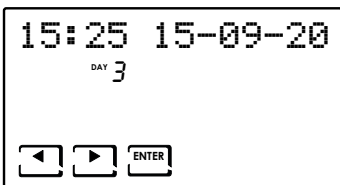

2  



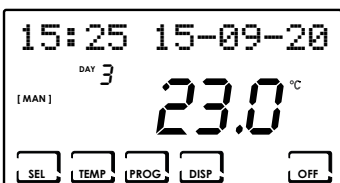

### 1.1 - SEASON

1   The season is displayed.

2    

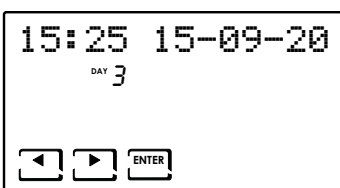
### 1.1 - VMC PROFILE (THE PROFILE ACCORDING TO THE PREVIOUS SETTINGS IS DISPLAYED)

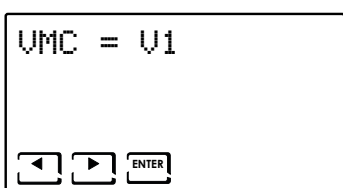
1  

2    

**Note:**

With integration active and ventilation in MAN will be displayed:

- VMC = INT

With integration off and ventilation in MAN will be displayed:

- VMC = V1

With ventilation in AUTO in both cases the set ventilation programme is displayed.

### 1.1 - INTEGRATION (ONLY AVAILABLE WITH THE INTEGRATION FUNCTION ACTIVE)

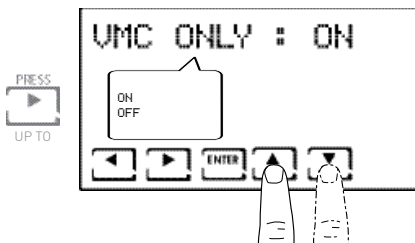
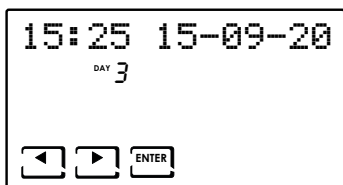
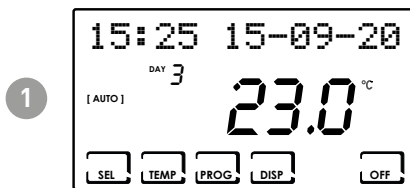

The operating status of the integration is displayed.

### 1.1 - AIR (RETURN AIR TEMPERATURE PROBE INSIDE THE VMC)

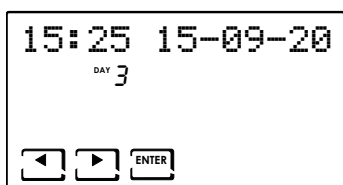
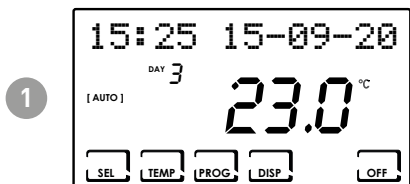

### 1.1 - H2 (EXHAUST AIR TEMPERATURE PROBE INSIDE THE VMC)

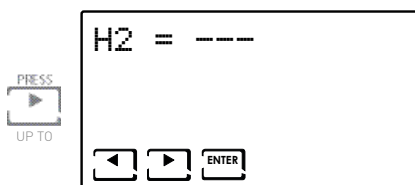
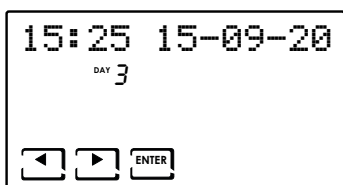
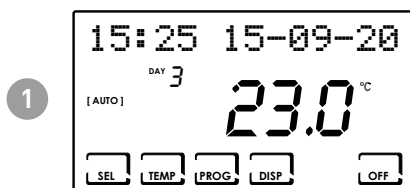

### 1.1 - H4 (OUTDOOR AIR INTAKE PROBE POSITIONED INSIDE THE VMC)

1

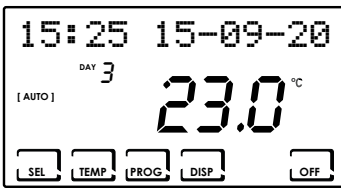

PRESS  
DISP

---

2

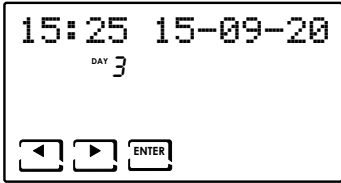

PRESS  
UP TO

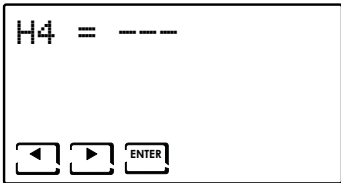

PRESS  
ENTER

### 1.1 - EXT (USED INPUT DISPLAY)

1

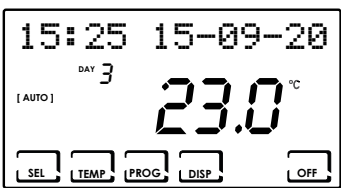

PRESS  
DISP

---

2

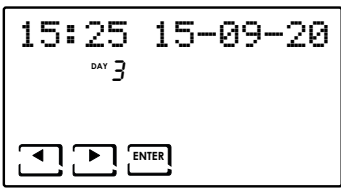

PRESS  
UP TO

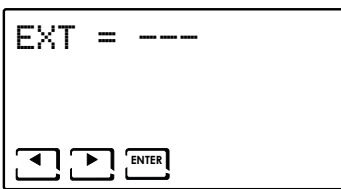

PRESS  
ENTER

The input used is displayed:

- --- = OFF
- ALR C = ALARM CLOSED
- ALR A = ALARM OPEN
- INTEG = INTEGRATION

### 1.1 - RH (RELATIVE HUMIDITY PROBE DISPLAY)

1

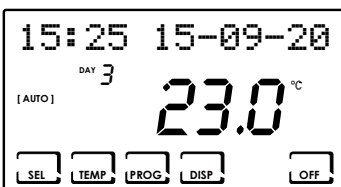

PRESS  
DISP

---

2

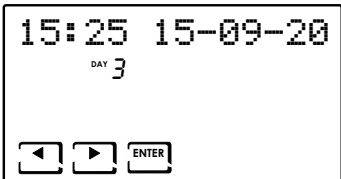

PRESS  
UP TO

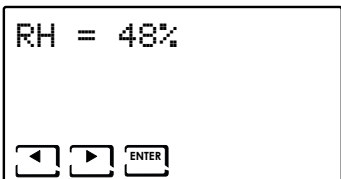

PRESS  
ENTER

## 1.1 - IAQ (AIR QUALITY PROBE DISPLAY)

1

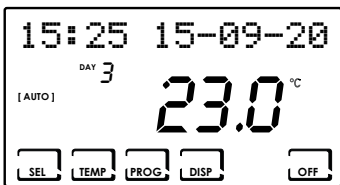

The IAQ (Indoor Air Quality) parameter indicates the level of ambient air quality detected by the sensor.

**Initial Display:** 15:25 15-09-20, DAY 3, [AUTO], 23.0 °C, [SEL] [TEMP] [PROG] [DISP] [OFF]

**Action:** PRESS [DISP]

2

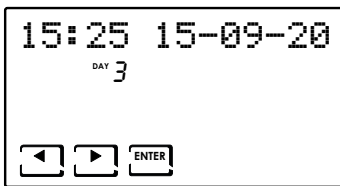
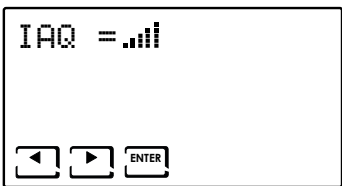
Quality of each notch:

- = very bad
- = poor
- = discreet
- = good
- = excellent

**Navigation:** [LEFT] [RIGHT] [ENTER]

**IAQ Display:** IAQ = ■■■■■

**Action:** PRESS [ENTER] UP TO

## 1.1 - DEW P (DISPLAY OF THE DEW POINT)

1

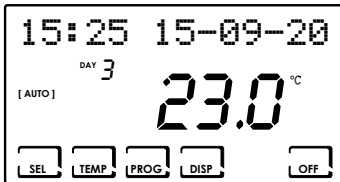

**Initial Display:** 15:25 15-09-20, DAY 3, [AUTO], 23.0 °C, [SEL] [TEMP] [PROG] [DISP] [OFF]

**Action:** PRESS [DISP]

2

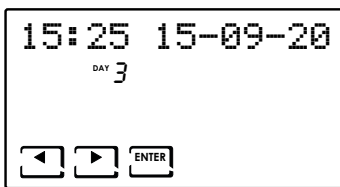
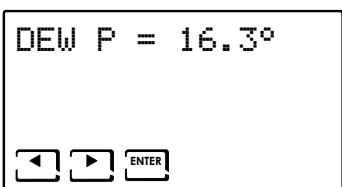
**Navigation:** [LEFT] [RIGHT] [ENTER]

**DEW P Display:** DEW P = 16.3°

**Action:** PRESS [ENTER] UP TO

## 1.1 - HOURS OF USE

The control records the total consumption of the hours the VMC system is switched on.

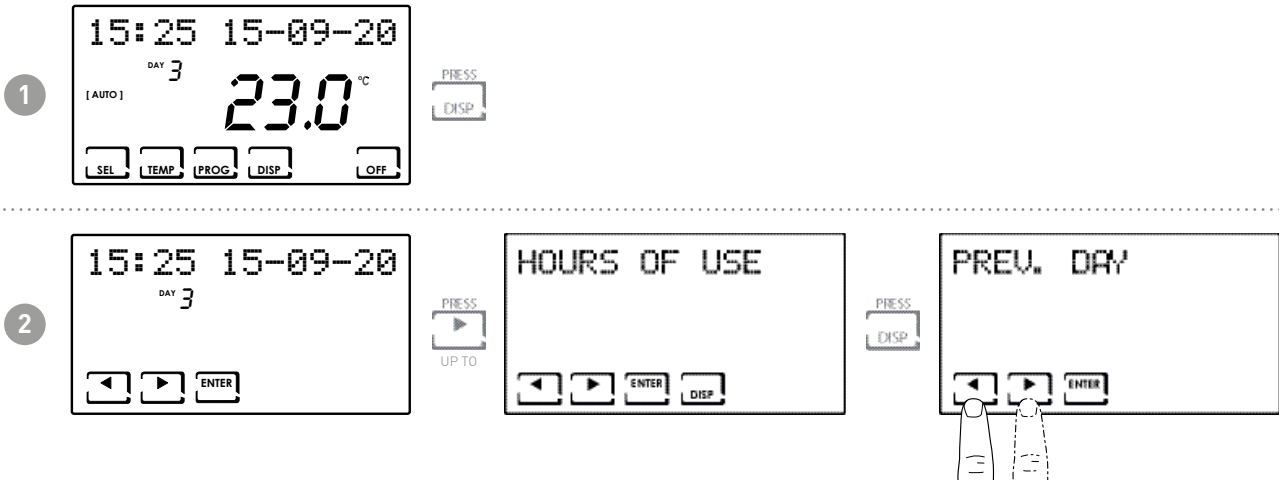

**Note:** you can display the user statistics for

- PREVIOUS DAY = total operating hours in the previous day
- CURRENT MONTH = total operating hours in the current month
- PREVIOUS MONTH = total operating hours in the previous month
- CURRENT YEAR = total operating hours in the current year
- TMAX = maximum room temperature measured the previous day
- TMIN = minimum room temperature measured the previous day
- RESET

Pressing DISP on the CURRENT MONTH, PREVIOUS MONTH, and CURRENT YEAR screens displays a graph with details on use (shown below).

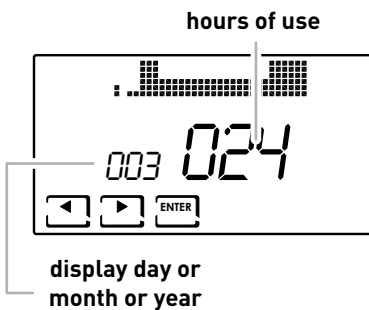

Pressing ◀ or ▶ allows you to scroll through and display the day of the month (or the month or year, depending on the page being displayed) and the hours of use.

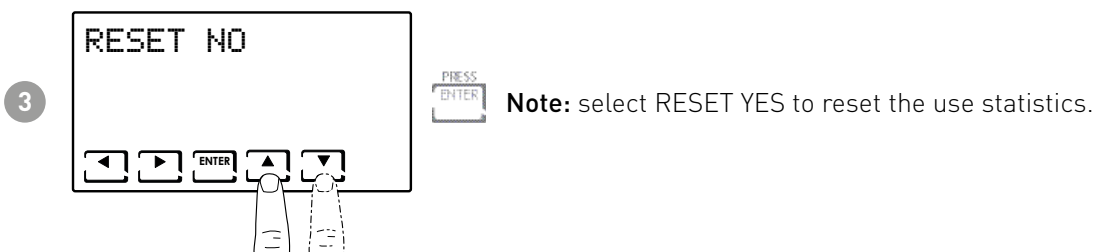



## 7 - ADVANCED FUNCTIONS (PROG)

To access ADVANCED PROGRAMMING, hold down the PROG key for a few seconds.

### 1.1 - SWITCHING ON DISPLAY

Allows you to adjust the display's backlight (sky blue light) with a duration that can be programmed between 5 and 30 seconds or always on.

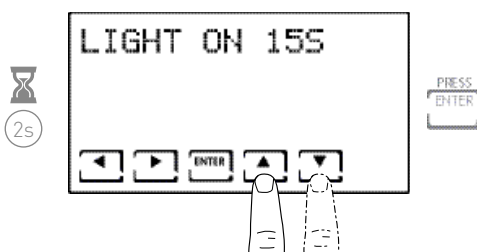
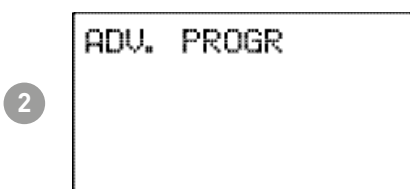
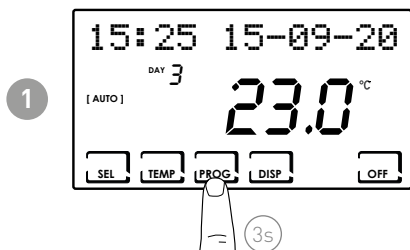

### 1.1 - DISPLAY LIGHTING INTENSITY

Allows you to modify the luminous intensity of the display, at 10 levels.

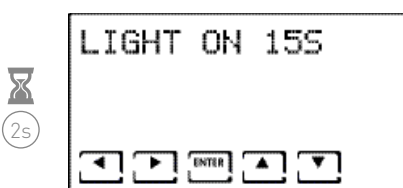
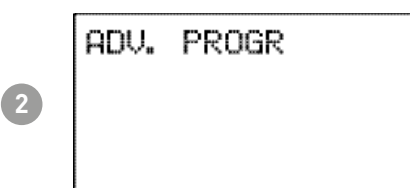
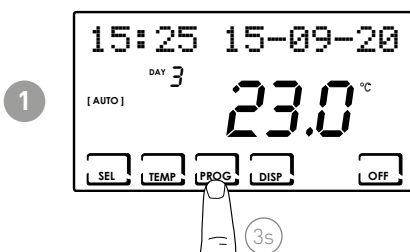

## 1.1 - DAYLIGHT SAVING / STANDARD TIME

Automatically selects daylight saving time, applicable in Europe and some other countries. This set-up automatically updates the time when it changes (March and October) (default = YES).

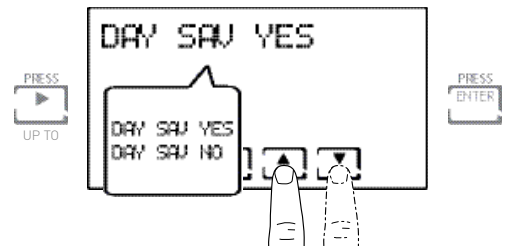
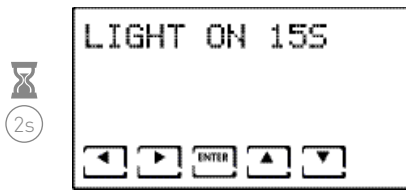
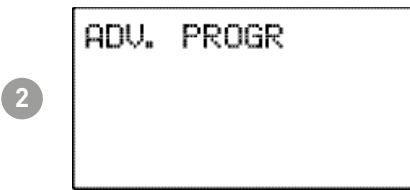
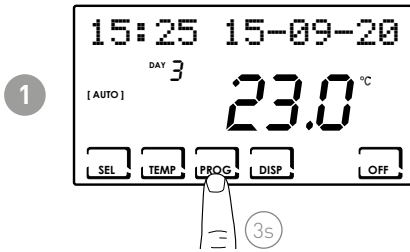

## 1.1 - VMC/ EXT HEAT

Function only available on VMCs: Codes AP20050,AP20052,AP20054,AP20056,AP20058

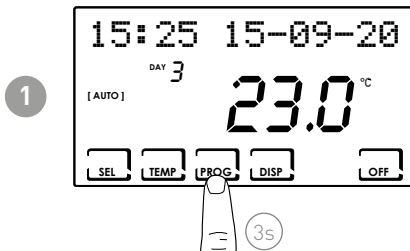

Allows the machine to be operated only in ventilation mode or with integration of heating from an external device.

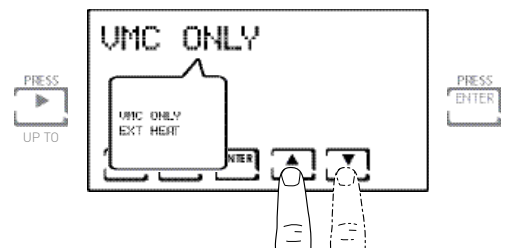
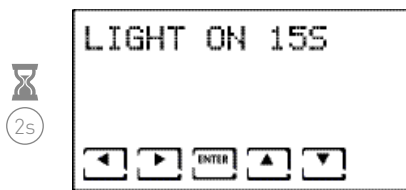
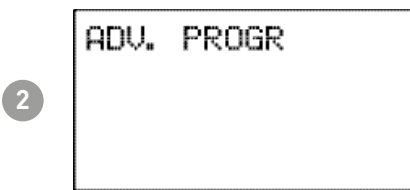

## 1.1 - VENTILATION

Allows the speeds of the VMC to be set according to the air flow rates defined in the design phase. Each speed can be set from 0 to 100% of the fan according to the logics defined in the following points.

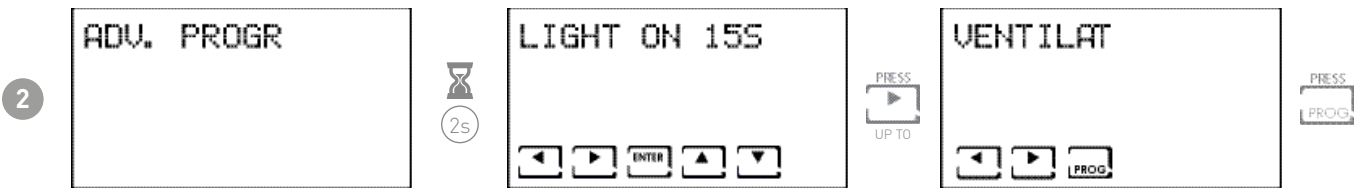
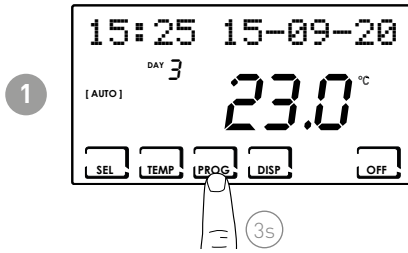

The following functions can be selected by pressing PROG:

- V1
- V3
- BOOST

### 1.1.1 - V1

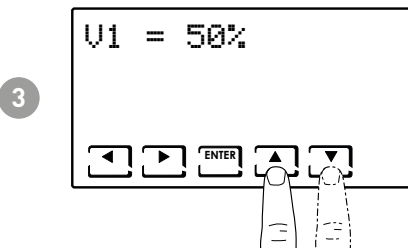
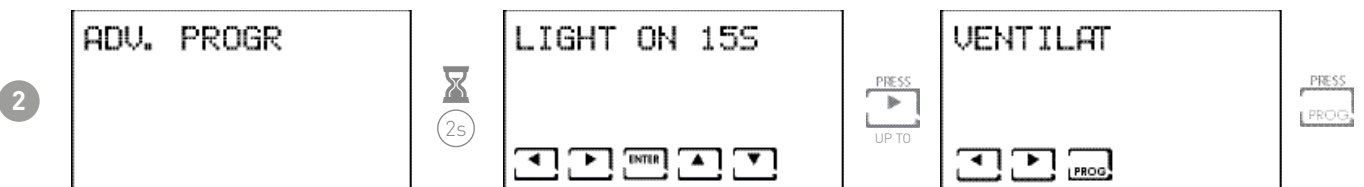
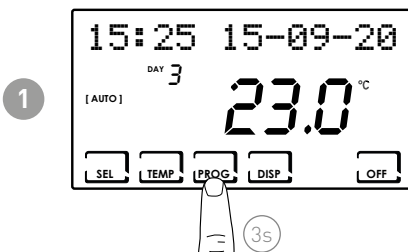

**Note:** V1 can be set between 10 and the minimum value of V3.

### 1.1.1 - V3

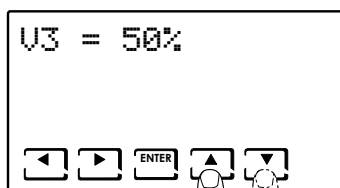
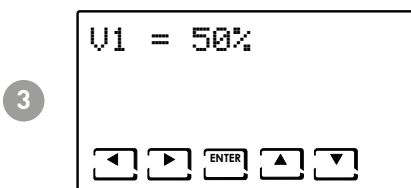
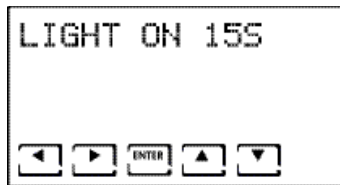
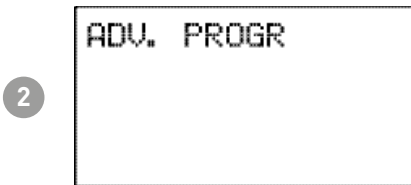
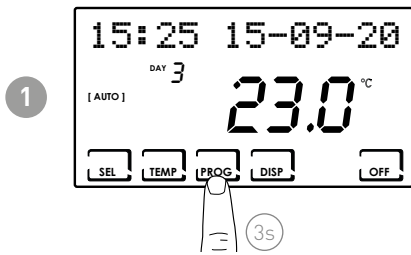

**Note:** V3 can be set between the maximum value of V1 and the minimum value of Boost.

### 1.1.1 - BOOST

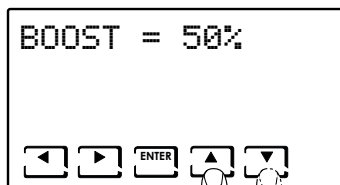
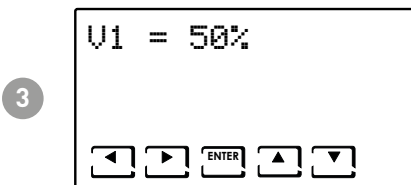
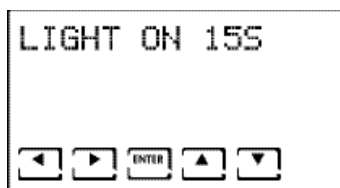
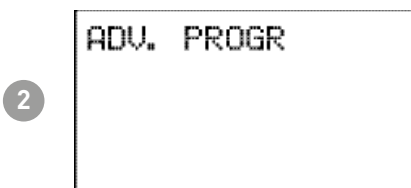
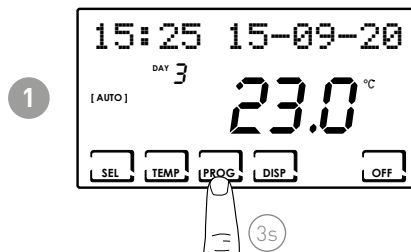

**Note:** BOOST can be set between the maximum of V3 and 100%.

### 1.1.1 - INT

Can only be set if the Integration function is active.

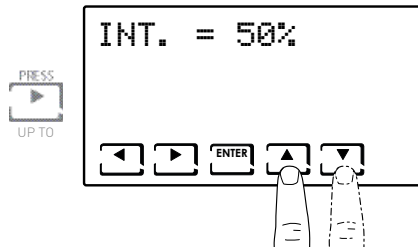
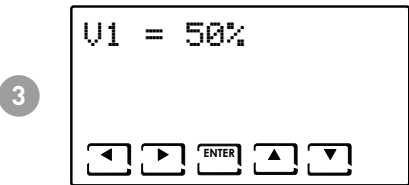
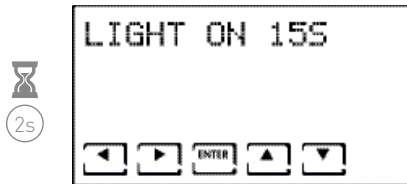
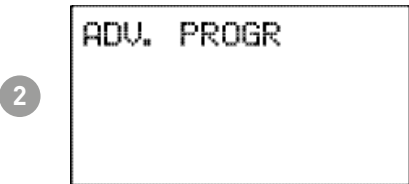
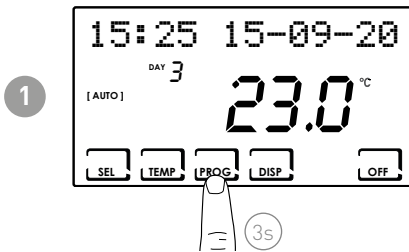

**Note:** INT can be set between 50% and 100%.

## 1.1 - INTEGRATION (THIS FUNCTION IS ONLY VISIBLE WHEN EXT HEAT IS ACTIVE)

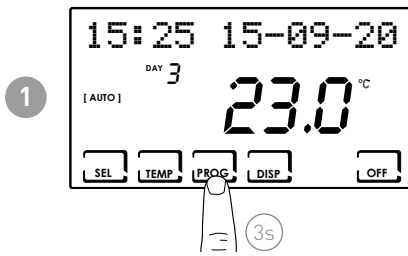

This function is activated when heating and/or cooling integration is desired.

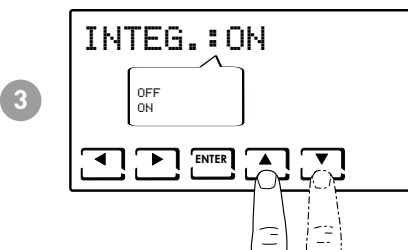
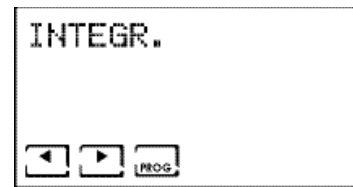
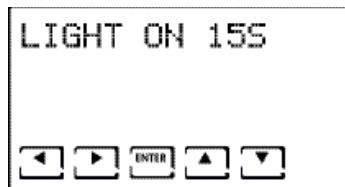
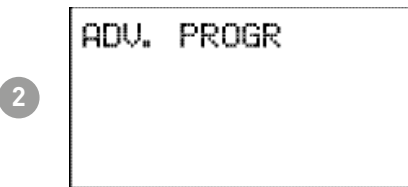

### 1.1.1 - MINIMUM TEMPERATURE

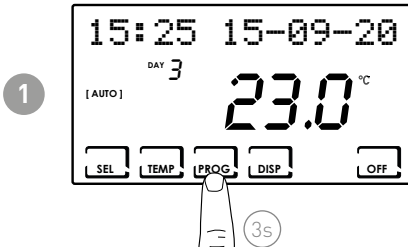

Defines the minimum value of the set point operating range that can be set between 5 and 35°C.  
T MIN < T MAX

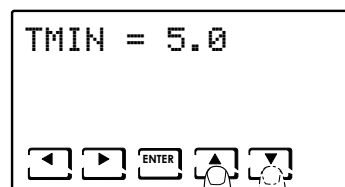
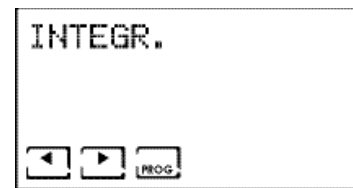
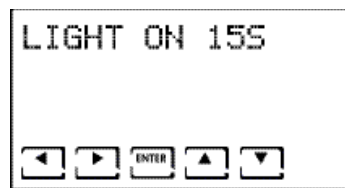
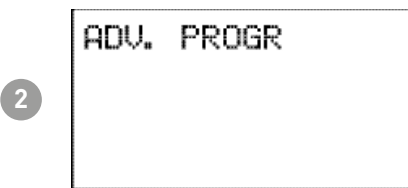

### 1.1.1 - MAXIMUM TEMPERATURE

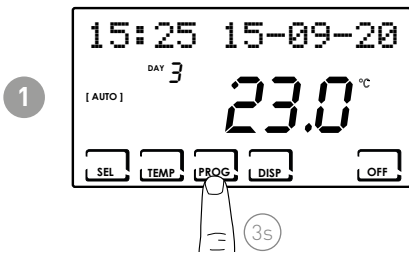

Defines the maximum value of the set point operating range that can be set between 5 and 35°C.  
T MIN < T MAX

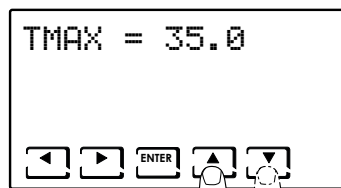
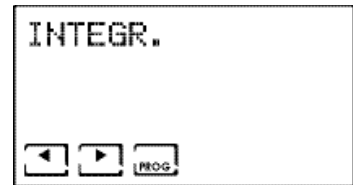
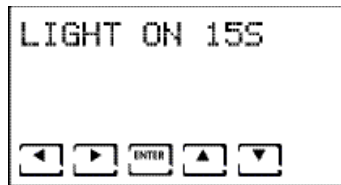
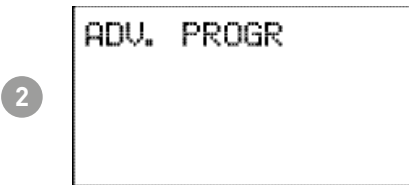

Note:

- t MAX can be set between T MIN and 35°C.

### 1.1.1 - DIFFERENTIAL MANAGEMENT

It allows the temperature difference between the OFF and ON status to be managed.

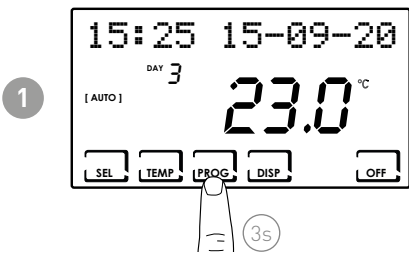

Note: the differential value that can be set is between 0.1 and 5.0°C.

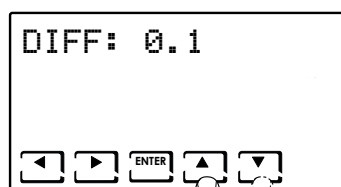
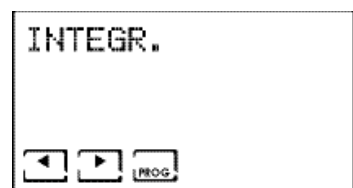
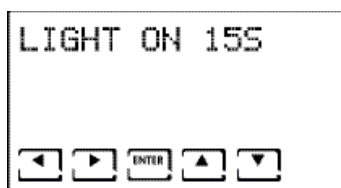
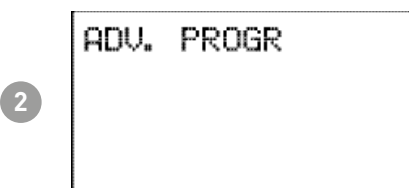

### 1.1.1 - ANTIFREEZE TEMPERATURE

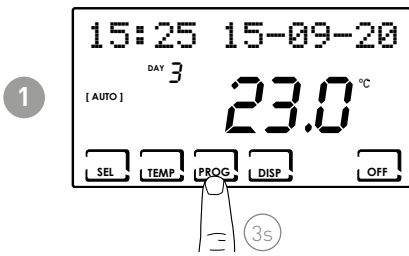

Note:

- the tA that can be set is between 5.0 and 7.0°C or OFF.

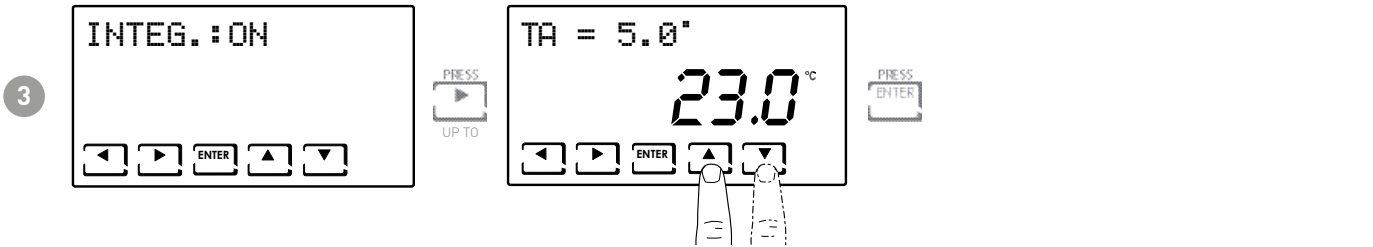
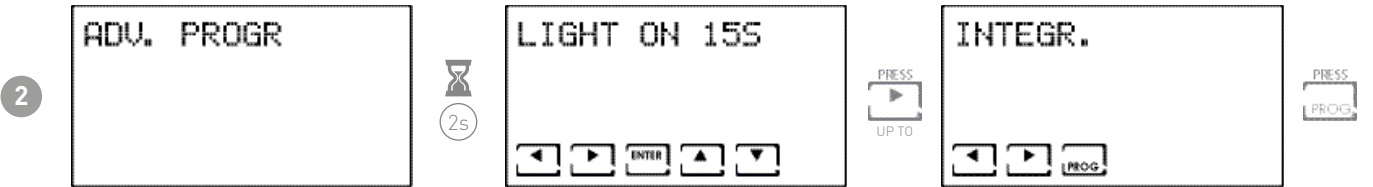

### 1.1 - ROOM TEMPERATURE CORRECTION

This allows you to modify the temperature read by the sensor inside the VMC, which, due to the recessed wall installation or perhaps a non-ideal height, might not indicate the true temperature perceived.

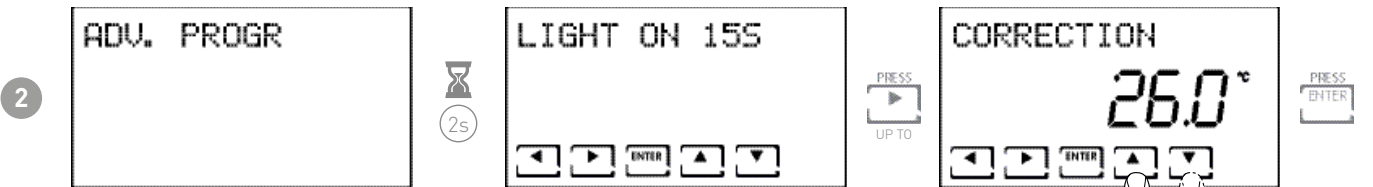
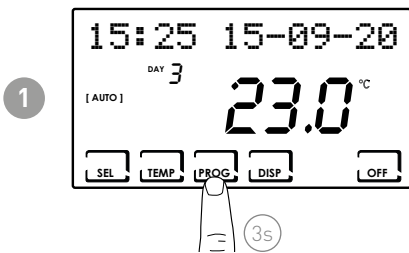



## 1.1 - CELSIUS / FAHRENHEIT

This allows you to choose the temperature display scale between Celsius and Fahrenheit degrees (default = CELSIUS).

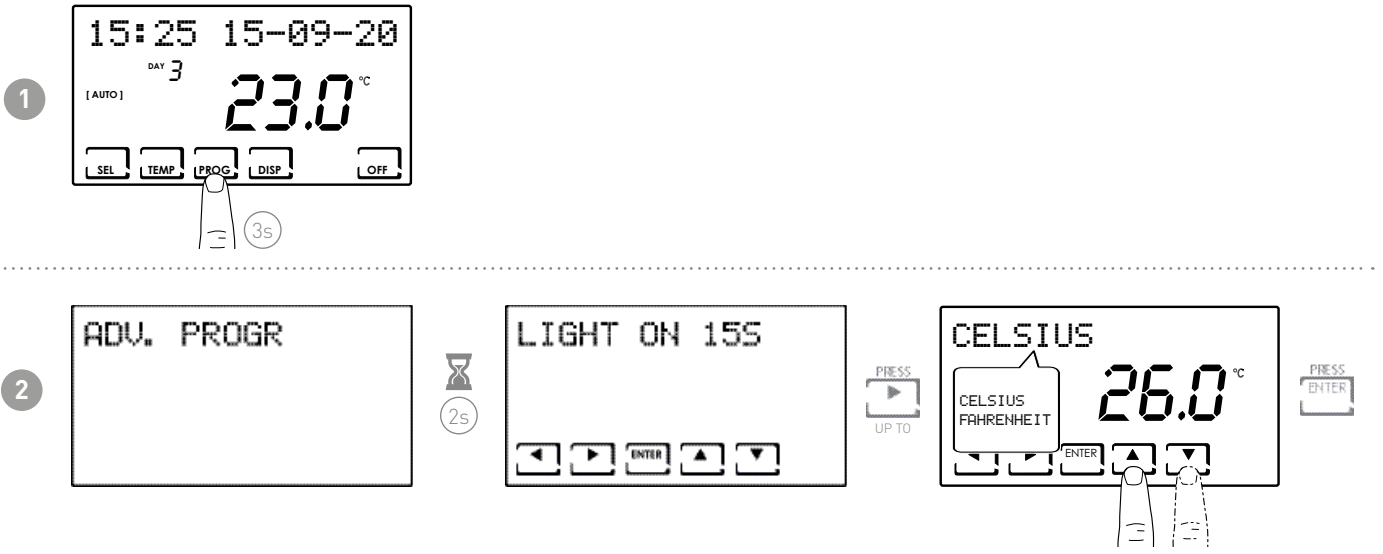

## 1.1 - BY PASS (ONLY AVAILABLE WITH SUMMER FUNCTION)

It allows the heat recovery unit to be bypassed by bringing air directly from outside into the room.

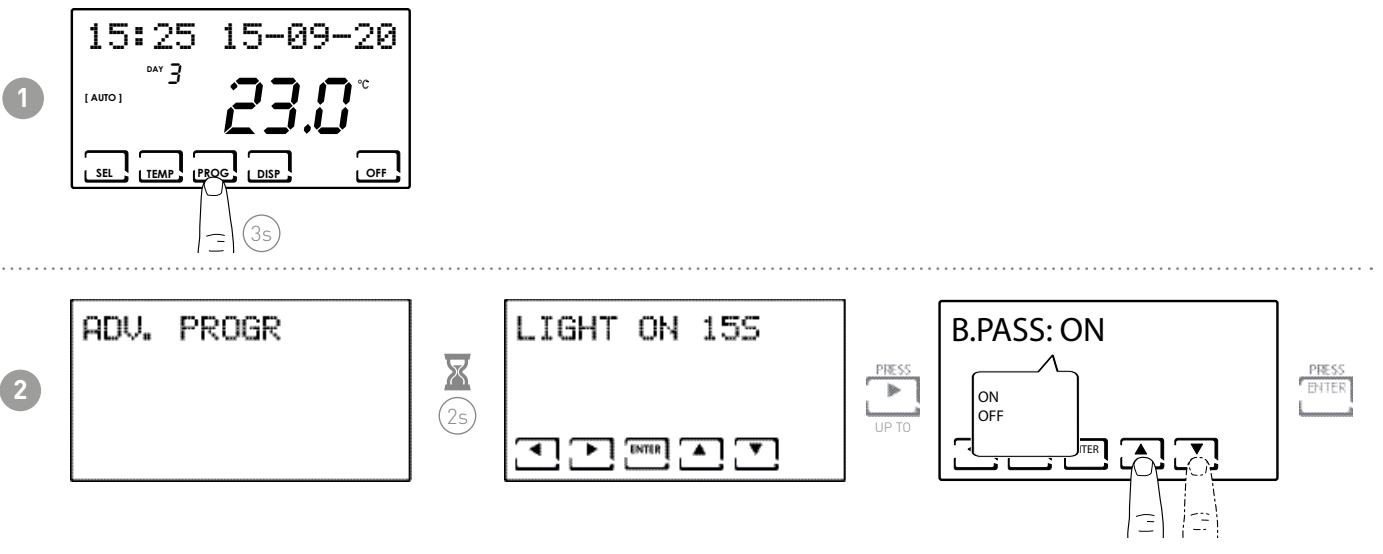

## 1.1 - SENS

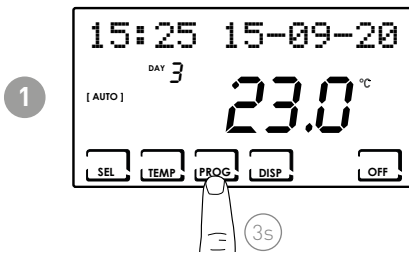

The CH193VMC modulates the ventilation (air flow rate) of the HVAC according to the values detected by the relative humidity (RH) and room quality (VOC) sensors on the device.

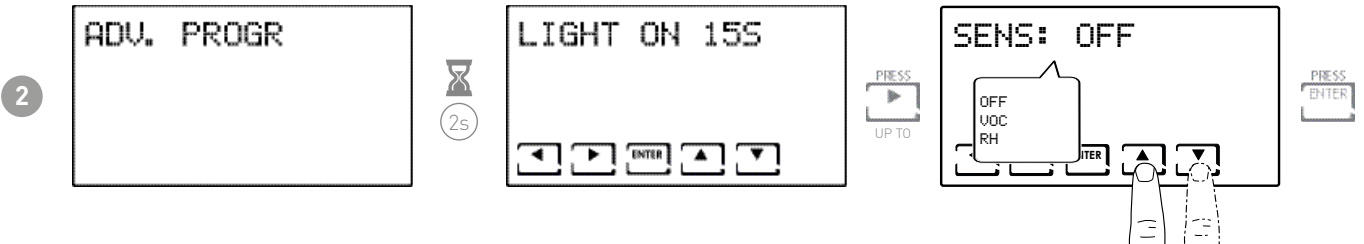

**Note:** selecting VOC or RH displays the PROG key.  
Then follow the procedure described in points 7.10.1 and 7.10.2

### 1.1.1 - RH

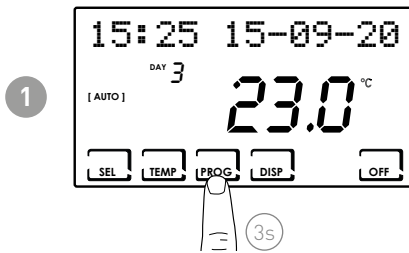

If the relative humidity in the room exceeds the set point values, the VMC automatically increases ventilation to re-establish the correct amount of relative humidity.

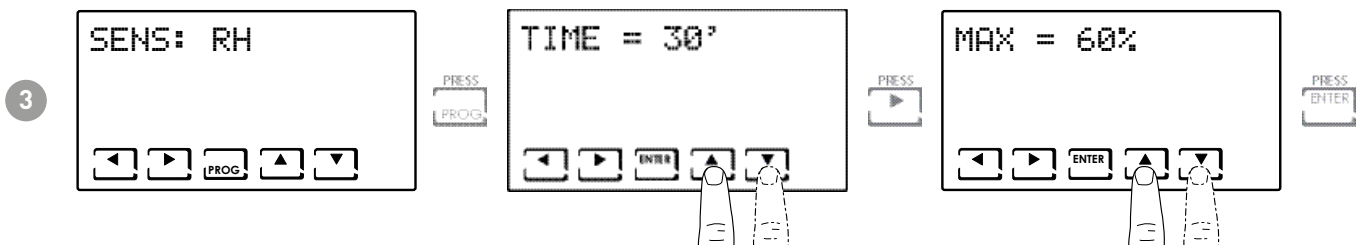
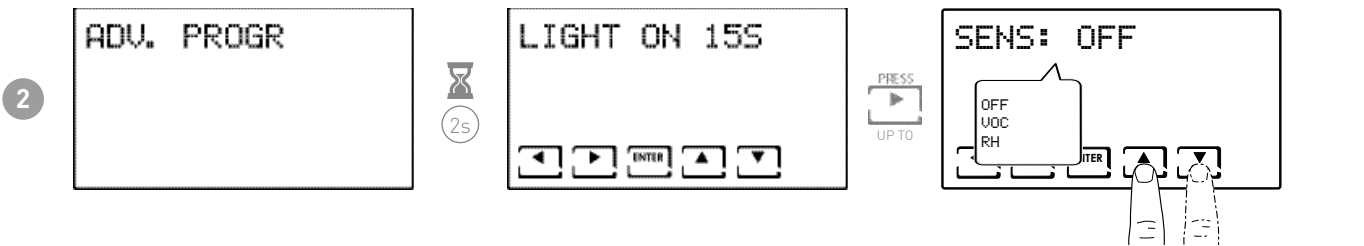

IS possible to select the intervention time between:

- 30 min
- 60 min
- 90 min

IS possible to select the intervention threshold from:

- MAX = --- Off, 40% to 90%

1.1.1 - VOC

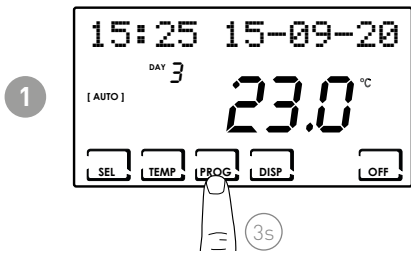

If the air quality in the room exceeds the set point values, the VMC automatically increases ventilation to re-establish optimum air quality.

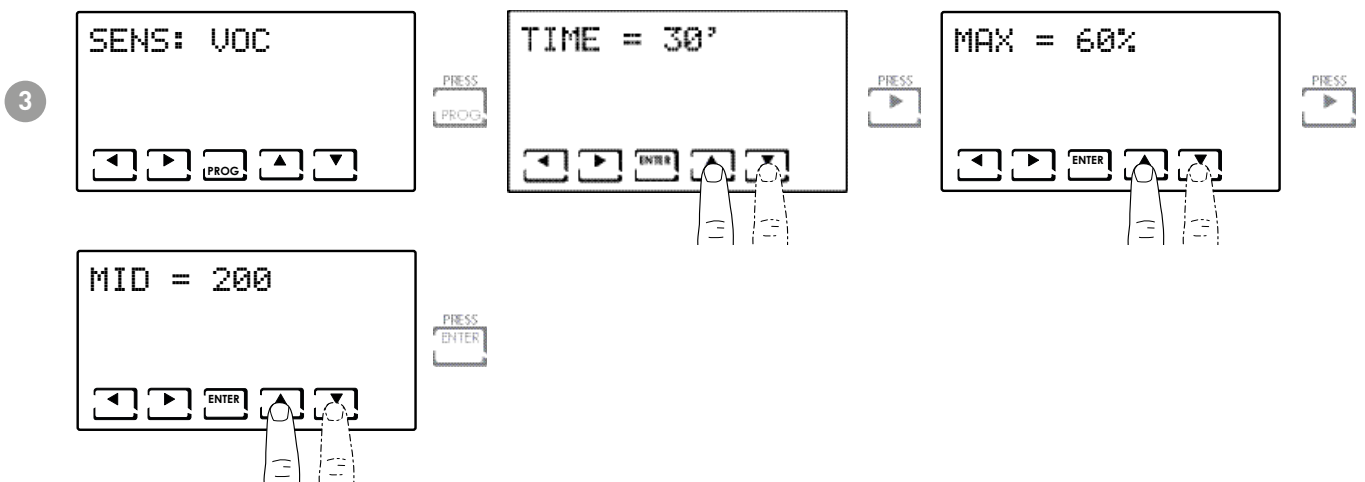
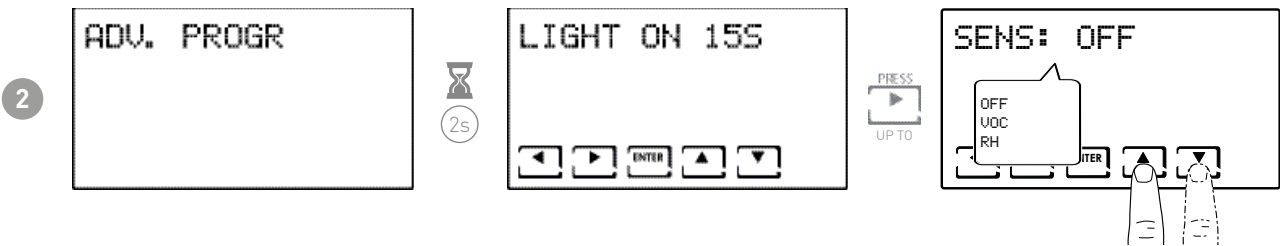

IS possible to select the intervention time between:

- 30 min
- 60 min
- 90 min

IS possible to select the intervention threshold from:

- MID = ---(Off), 100 to MAX
- MAX = ---(Off), MID to 500

## 1.1 - FILT

Allows you to set a parameter (in hours) for changing filters.

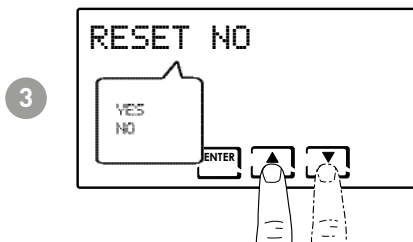
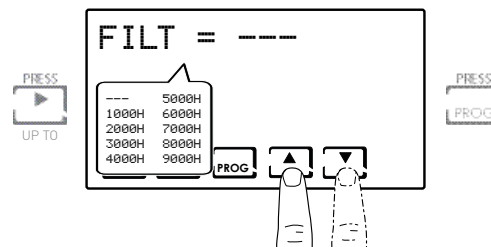
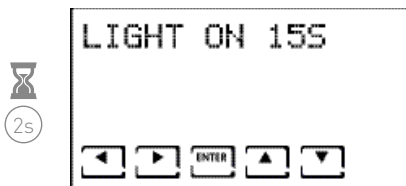
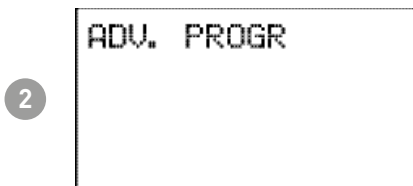
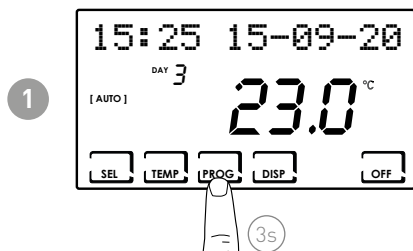

## 1.1 - LANGUAGE SELECTION

Allows you to change the language used during programming (default = ITALIAN).

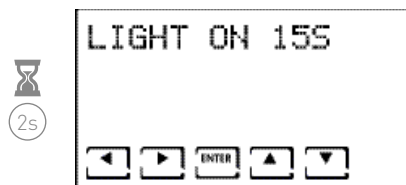
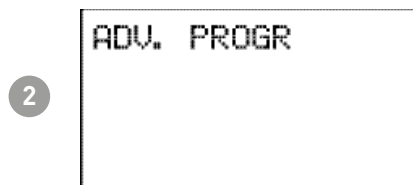
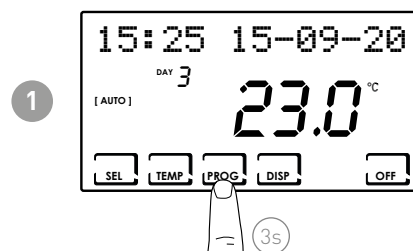

## 1.1 - ALARMS

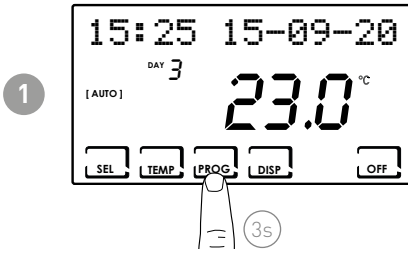

The VMC has a self-diagnostic function that can detect up to 16 different types of faults. The details of the faults are shown in the tables below, where the presence of the figure "1" in a specific position indicates the respective fault.

AL1

00000000

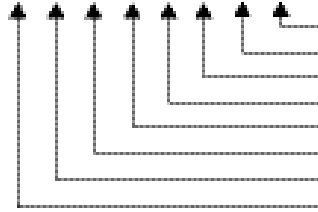

COMM:	communication error
SENS AIR:	AIR probe
SENS H4:	H4 probe
BAD WATER:	N.D.
SENS H2:	H2 probe
BAD H4:	H4 unsuitable
OT RESISTANCE:	high temp resistance
MOTOR:	motor failure

AL2

00000000

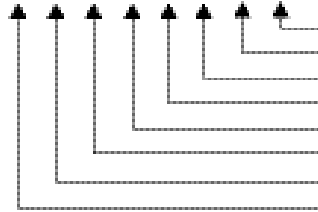

SW GRL:	SW GRL open
BAD H2:	H2 unsuitable
FILTERS:	filter cleaning
---	
---	
EXT CLOSE:	external contact closed
EXT OPEN:	external contact open

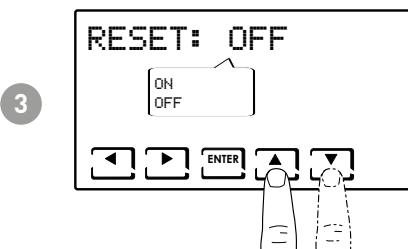
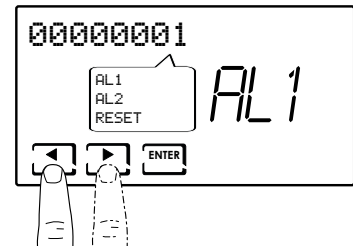
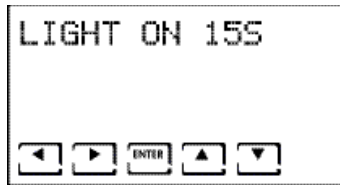
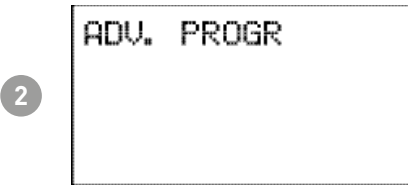

## 1.1 - EXT IN

Allows you to set the input to be used on the system.

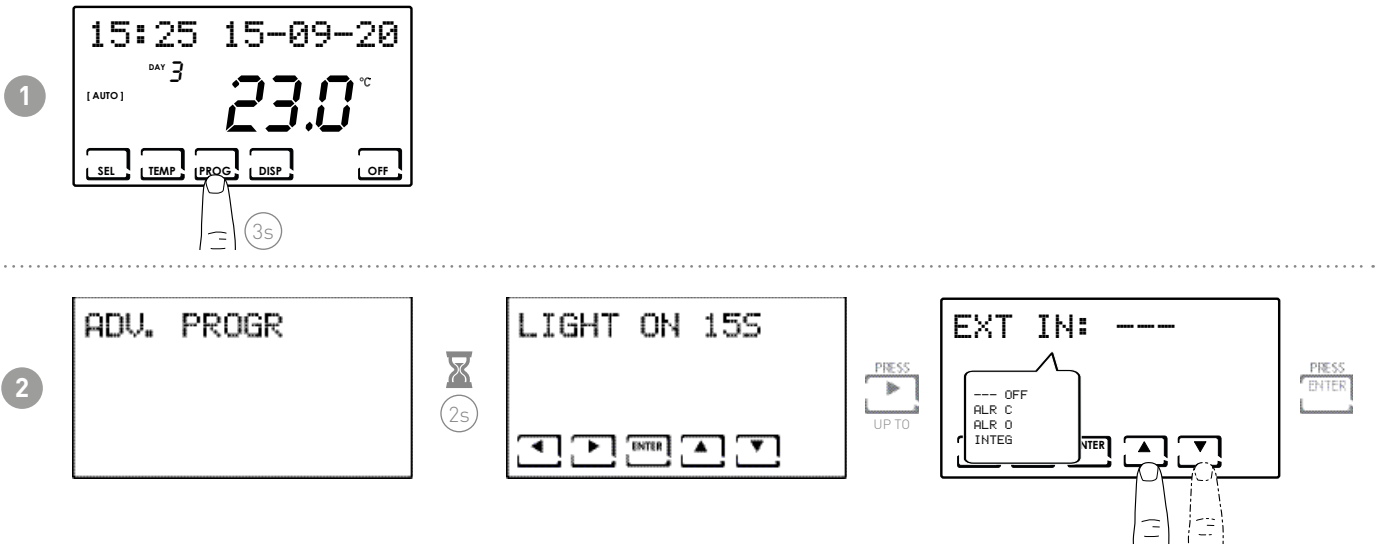

## 1.1 - CHG

Allows automatic change of season.

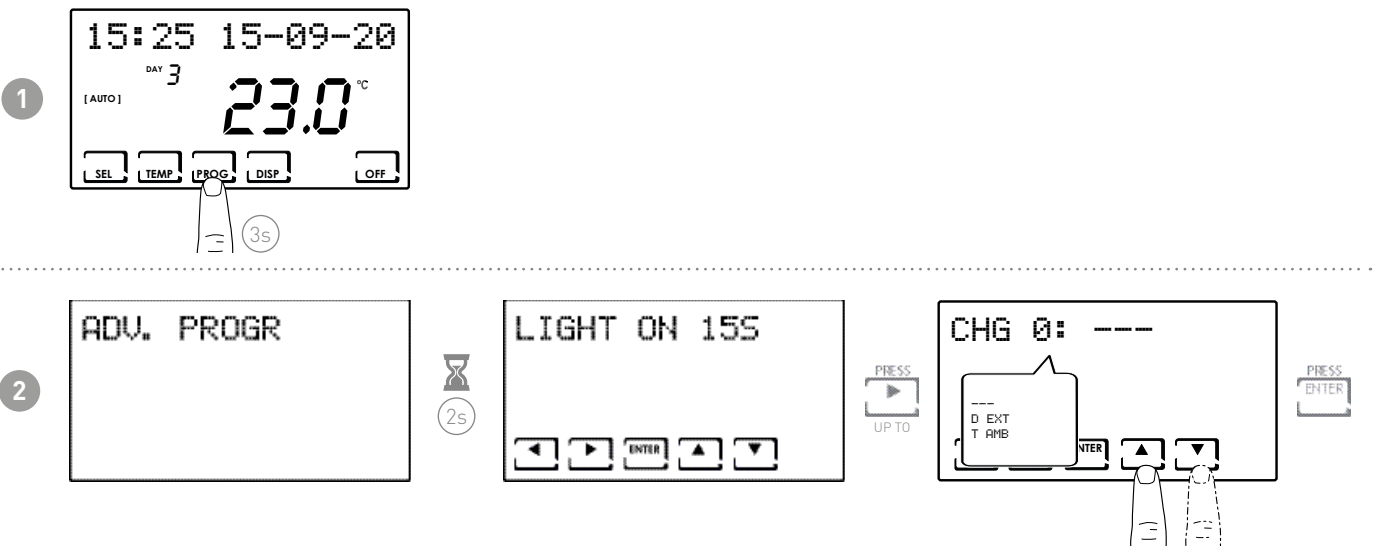

**Note:** selecting T AMB displays the PROG key. Then follow the procedure described in points 3.

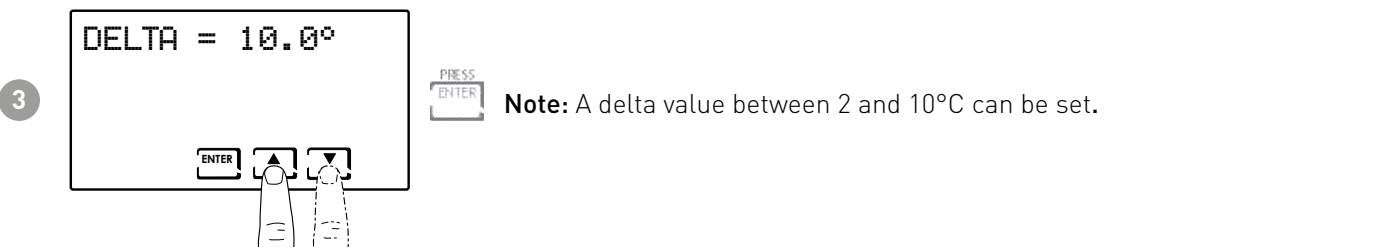

## 1.1 - SOUND ALARM

Allows for an audible alarm in case of anomalies.

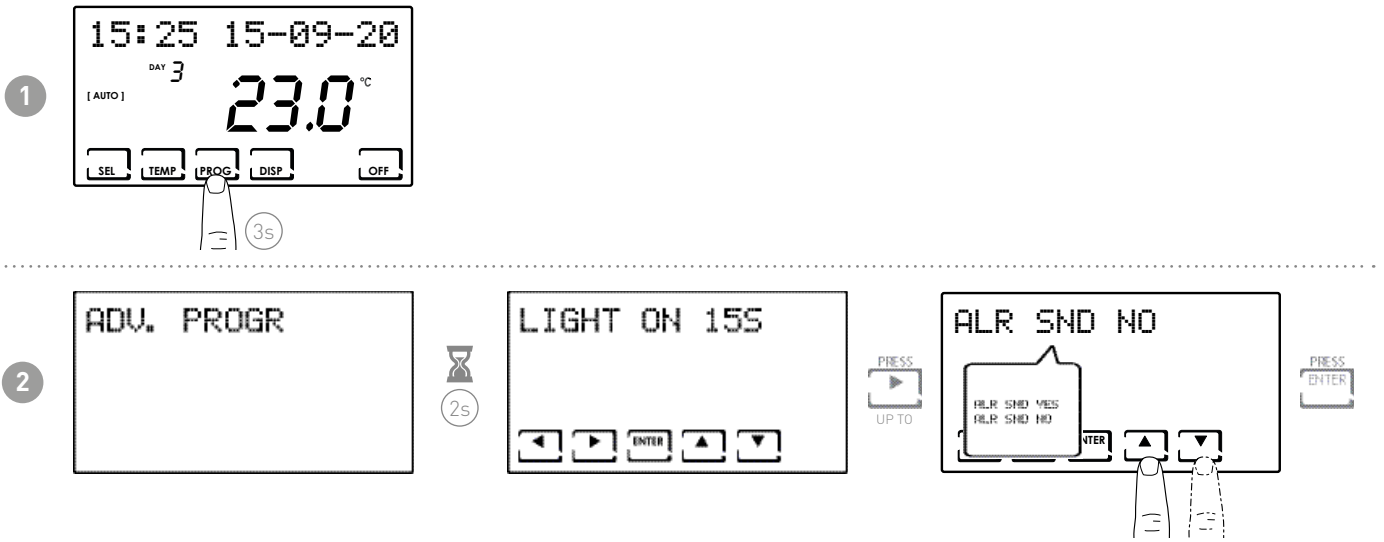

## 1.1 - BEEP

Allows for an acoustic signal when keys are pressed.

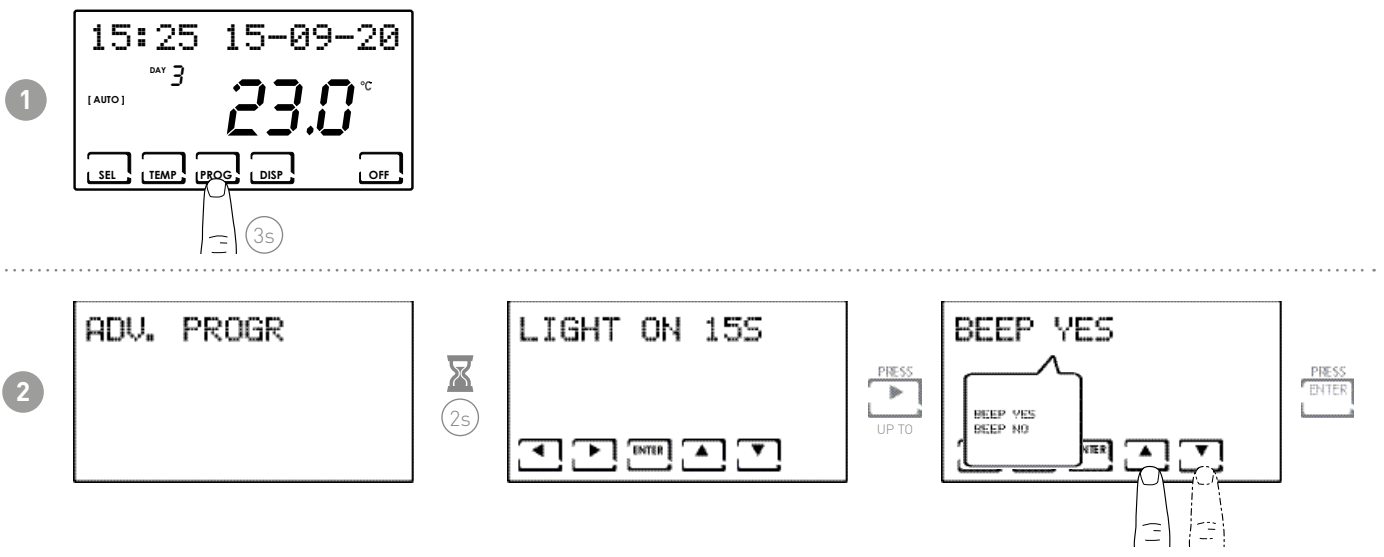

## 1.1 - LED

Allows the LED on the front of the CH193VMC panel to flash.

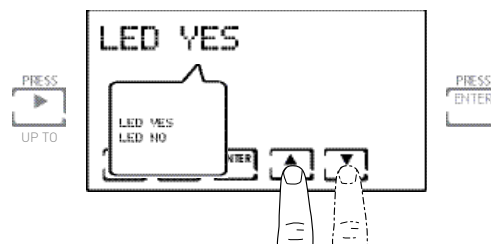
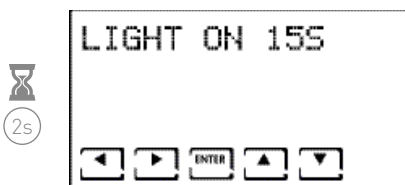
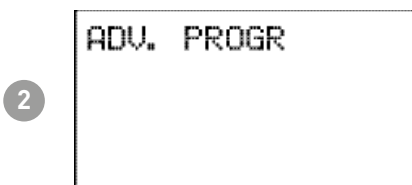
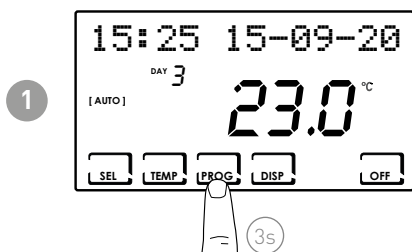

## 1.1 - INFORMATION

Displays the software version of the programmable thermostat.

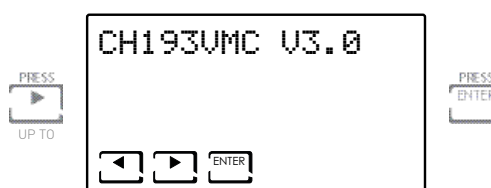
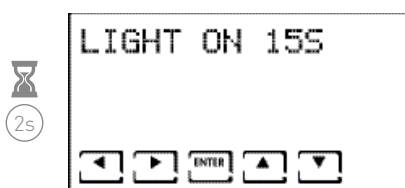
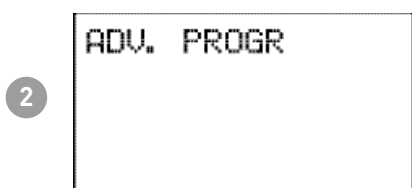
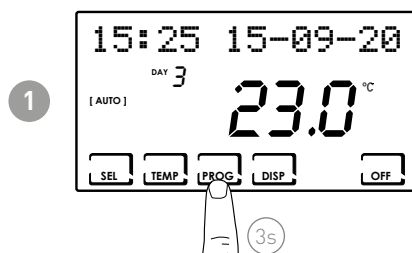



## 1.1 - RESETTING DEFAULT PARAMETERS

This allows you to reset all the parameters (except date and time) to the factory settings.

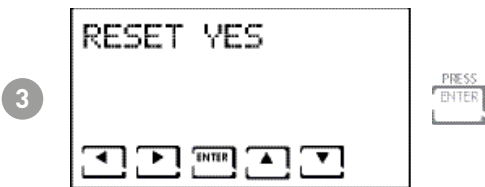
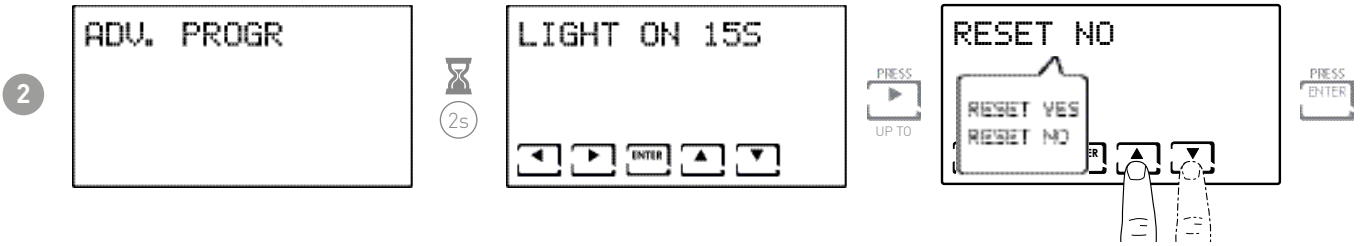
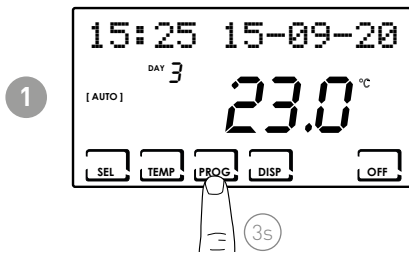

## 8 - DISPOSAL



The symbol of the crossed-out wheeled bin indicates that the products must be collected and disposed of separately from household waste. The batteries and integrated accumulators may be disposed of together with the product. They will be separated at the recycling facilities. A black bar indicates that the product was placed on the market after 13 August 2005. Participating in the separate collection of products and batteries contributes to the correct disposal of these materials and therefore avoids possible negative consequences for the environment and human health. For more detailed information on the collection and recycling programmes available in your country, contact the local authorities or the sales point where you purchased the product.

## 9 - GENERAL WARRANTY CONDITIONS

The conventional warranty lasts 24 months, starting from the date the equipment is installed. The warranty covers all parts of the equipment, with the exception of those subjected to normal wear through use.



EAC CE

EN79973E - 10/2022



**FANTINI COSMI S.p.A.**  
Via dell'Osio, 6 20049 Caleppio di Settala, Milan – ITALY  
Tel. +39 02 956821 | Fax +39 02 95307006 | [info@fantinicosmi.it](mailto:info@fantinicosmi.it)  
[www.fantinicosmi.it](http://www.fantinicosmi.it)