



INSTRUCTIONS FOR USE

CH180WIFI

TOUCH-SCREEN PROGRAMMABLE THERMOSTAT
WITH WIFI CONNECTION



FANTINI COSMI S.p.A.

Via dell'Osio, 6 20090 Caleppio di Settala, Milan – ITALY
Tel. +39 02 956821 | Fax +39 02 95307006 | info@fantinicosmi.it
www.fantinicosmi.it

Thank you for purchasing a **FANTINI COSMI S.p.A.** product.

Please read this instruction manual carefully and always keep it at hand should you need to consult it for any reason.

The documentation reflects the characteristics of the product. However, for regulatory or commercial developments, customers should verify the availability of updates relating to this documentation on the FANTINI COSMI S.p.A. website: pdf.fantincosmi.it

OPERATION

The CH180WIFI is a programmable thermostat with a WiFi connection to control heating and/or cooling system either directly or via the Intelliclimate+ APP on a smartphone or tablet.

It has a customised temperature program on a time profile for every season, which can be changed as needed.

The positive LCD display with white backlighting can also show an intuitive graph of the energy consumption of the entire system.

CONTENTS OF PACKAGE

- 1 programmable thermostat
- 2 6/32UNC American standard thread screws to secure onto 503 flush mounting box (approximately Ø 3.5mm)
- 1 quick guide

DESCRIPTION OF DISPLAY KEYS

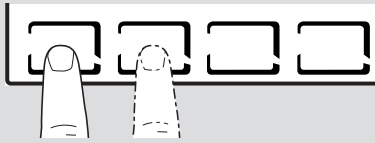

The first time any touch key is pressed, this activates the functions of the buttons themselves and lights up the display.

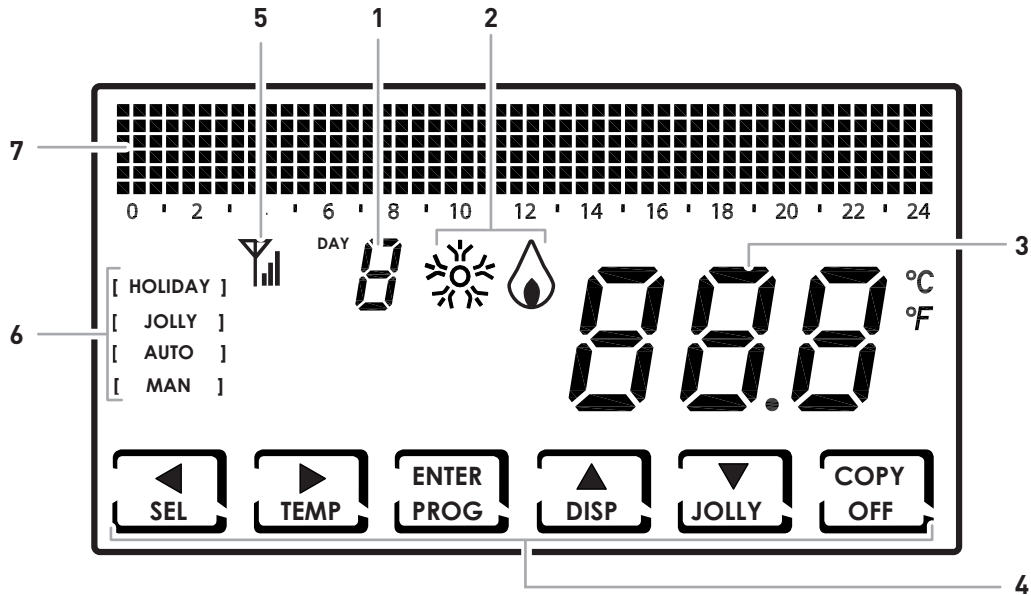

- | | |
|---|---|
| 1 | Day of the week |
| 2 | Activation status: air conditioning or heating |
| 3 | Room temperature (Celsius / Fahrenheit) measured |
| 4 | Multi-function touch icons |
| 5 | Antenna |
| 6 | Operating mode |
| 7 | Bar graph to display messages and daily programming |

The function of the multi-function keys varies depending on the situation and is described by the symbol that appears on the display next to the key.

TECHNICAL FEATURES

Temperature regulation scale	2 - 40°C, 0.1°C increment
Measurement scale/room T display	- 50 - + 50°C
Power supply	230V 50 Hz
Output type	1 relay with potential-free changeover contact (COM/NO/NC) 3 screw clamps (closed + open)
Contact range	5(3)A 250 Vac
Type of action	1 B.U. (connection micro-switch)
Software	class A
Minimum regulation differential	0.3 - 5 K
Reference thermal gradient	4 K/h
Maximum room temperature	45°C
WiFi connection	2.4 GHz (802.11 b/g/n)
Router communication port	1080
Maximum radio frequency power transmitted	< 10 mW
Storage temperature	-10°C - +60°C
Electric insulation	Double insulation
Protection rating	IP40
Pollution degree	2
Pulse voltage	4000V
Assembly	wall-mounted or on flush mounting box
Dimensions	127 x 82 x 24 mm
Compliant with	EN 60730-1 standards and second parts
ErP classification	■ ErP Class IV; 2% [Reg. EU 811/2013 - 813/2013]
Compliant with Directive	2014/53/EU (RED)

Product made in Italy

Contents

OPERATION	2	6.9 - WIFI	25
CONTENTS OF PACKAGE	2	6.10 - INFORMATION	25
DESCRIPTION OF DISPLAY KEYS	3	6.11 - RESETTING DEFAULT PARAMETERS.....	26
TECHNICAL FEATURES	4	7 - REMOTE PROGRAMMING VIA APP	27
1 - INSTALLATION	6	7.1 - WIFI ACTIVATION	27
2 - ELECTRICAL CONNECTION	8	7.2 - INSTALLATION PROCEDURE	28
3 - QUICK PROGRAMMING GUIDE (PROG)	9	7.3 - WIFI STATUS	29
3.1 - DATE AND TIME SETTING	9	8 - DISPOSAL	30
3.2 - WINTER/SUMMER SETTING	10	9 - GENERAL WARRANTY CONDITIONS	30
3.3 - HOURLY PROGRAMMING SETTING (PROFILE).....	10		
3.4 - SETTING THE DISPLAY	12		
3.5 - SETTING KEYBOARD LOCK WITH PASSWORD	13		
4 - OPERATION (SEL)	14		
4.1 - OPERATING PROGRAMS	14		
4.2 - SELECTING THE OPERATING PROGRAM.....	15		
4.3 - "JOLLY" PROGRAM SETTING.....	16		
4.4 - SETTING "AUTO" and "HOLIDAY" PROGRAM TEMPERATURE	17		
4.5 - SETTING "MANUAL" and "JOLLY" PROGRAM TEMPERATURE ...	17		
5 - PARAMETER DISPLAY (DISP)	18		
5.1 - DATE AND TIME	18		
5.2 - SEASON	18		
5.3 - PROFILE.....	19		
5.4 - SERIAL NUMBER.....	19		
5.5 - HOURS OF USE.....	20		
6 - ADVANCED FUNCTIONS (PROG)	21		
6.1 - SECONDS DISPLAY STAYS ON	21		
6.2 - DISPLAY LIGHTING INTENSITY.....	21		
6.3 - DAYLIGHT SAVING TIME.....	22		
6.4 - ANTIFREEZE TEMPERATURE	22		
6.5 - ROOM TEMPERATURE CORRECTION	23		
6.6 - DIFFERENTIAL MANAGEMENT.....	23		
6.7 - CELSIUS / FAHRENHEIT	24		
6.8 - LANGUAGE SELECTION	24		

1 - INSTALLATION



ATTENTION!

Installation must be carried out by qualified personnel in compliance with the requirements concerning the installation of electrical equipment.



ATTENTION!

Installation operations must be performed with the system's power disconnected.

The CH180WIFI programmable thermostat must be installed on the wall or on a flush mounting box, in 3 units or round, at a height of about 1.5m from the floor, in a suitable position to detect the room temperature correctly.

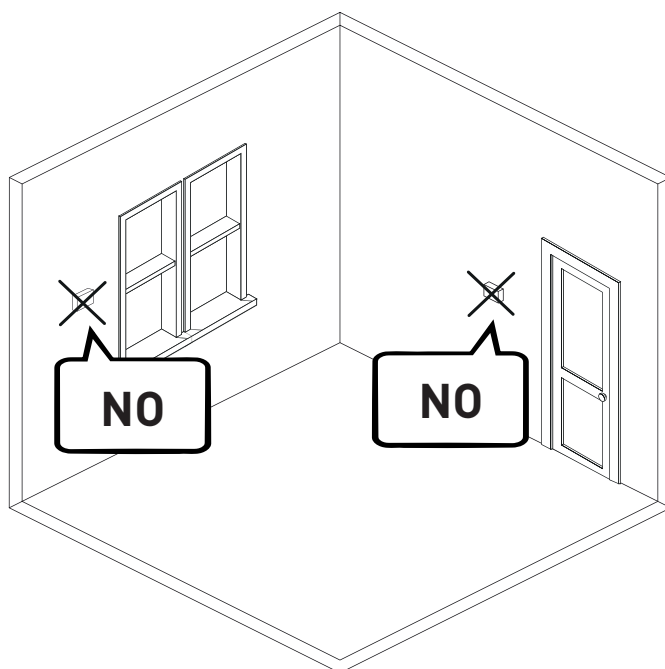
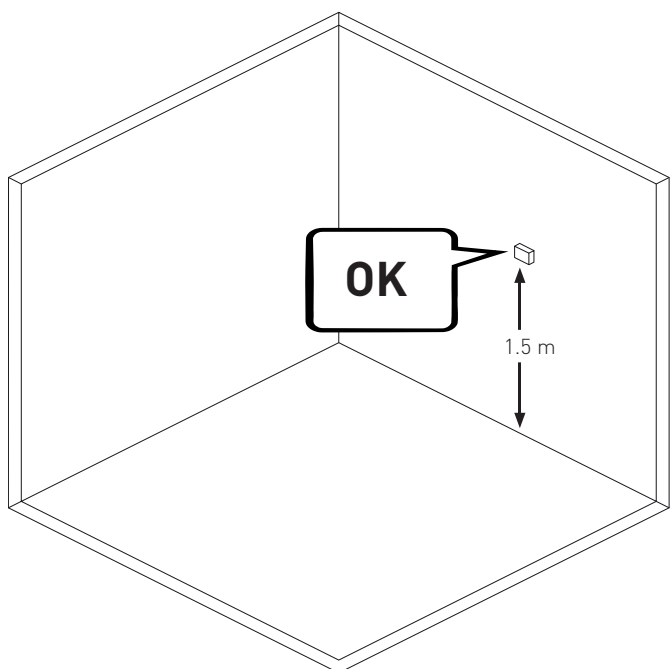
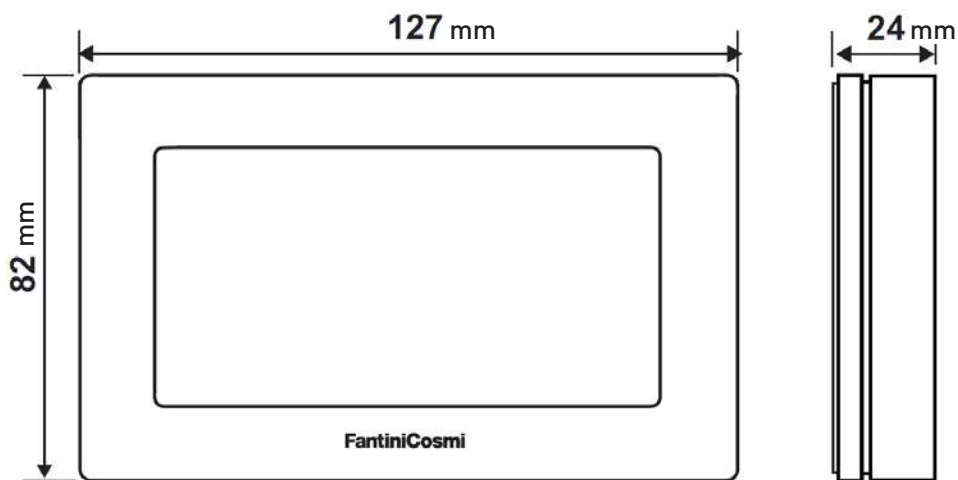

Pry the back panel off the body by applying pressure to the specific groove on the lower part.

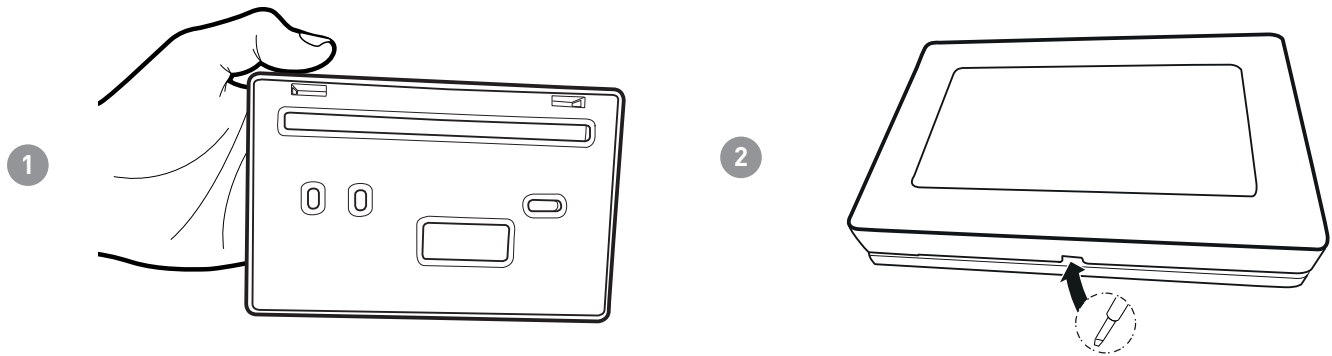

Remove the insulating protection by unscrewing the specific waterproof screw.

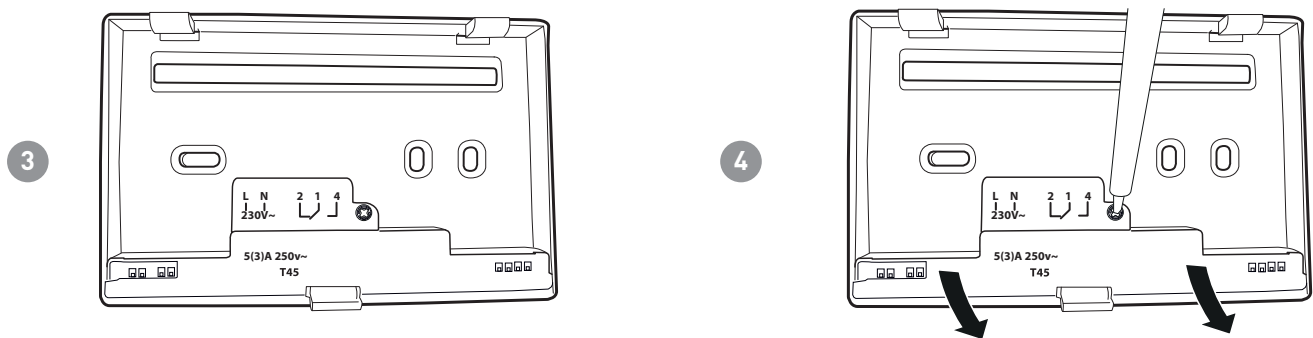

Make the electrical connections (refer to the "Electrical connections" paragraph) and secure the panel to the wall with the supplied screws.

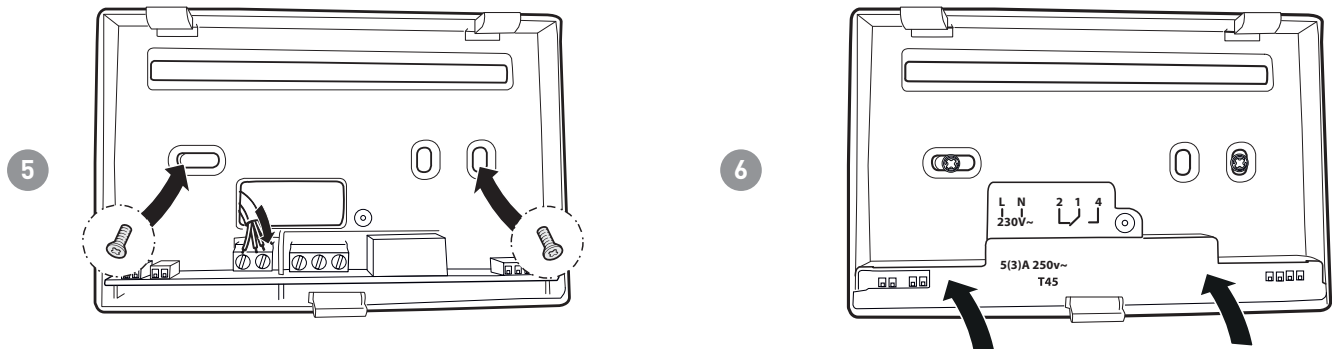

Tighten the screw shown and hook the body onto the panel on the wall.

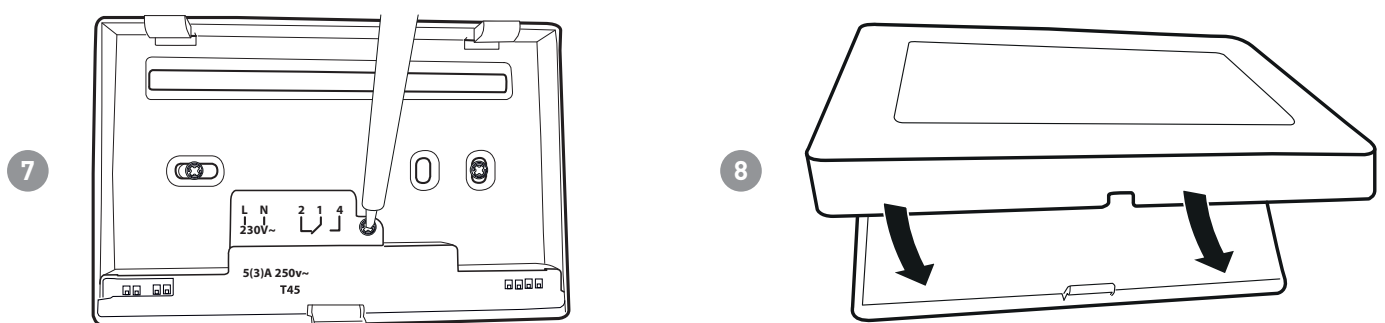

2 - ELECTRICAL CONNECTION



ATTENTION!

Electrical connections must be made by qualified personnel.



ATTENTION!

Electrical connection operations must be done with the system's power disconnected.

Electrical connections must be made by making reference to the following diagram.

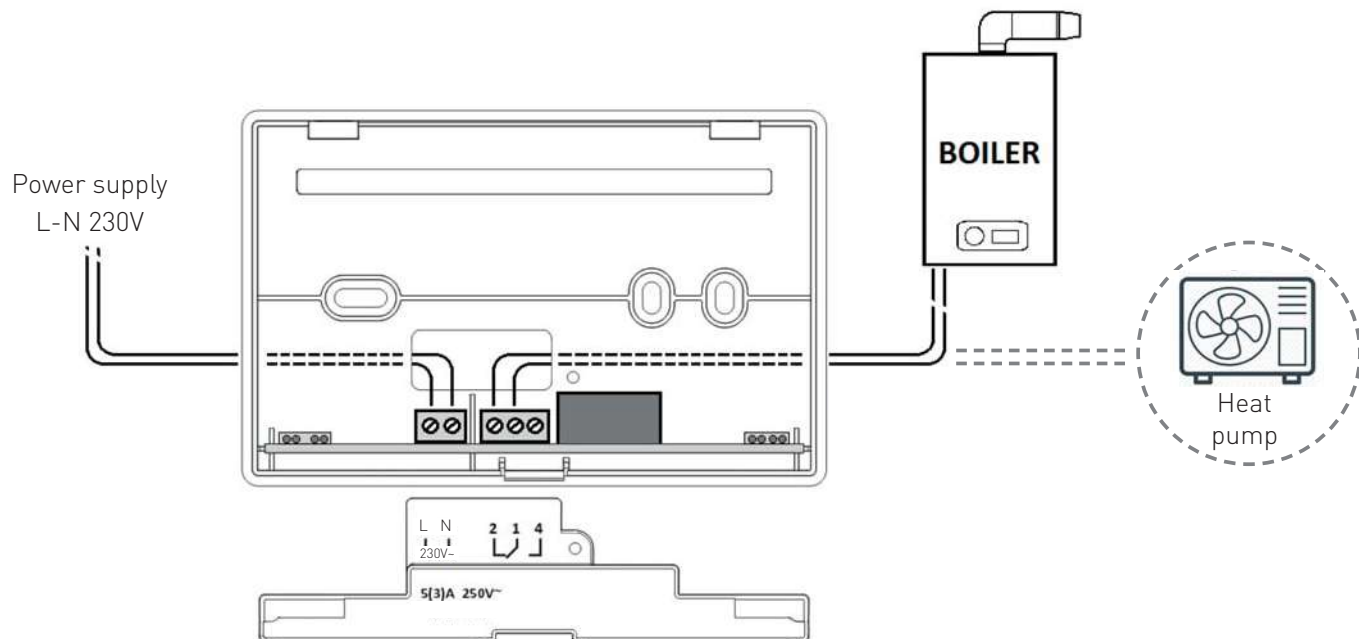

3 - QUICK PROGRAMMING GUIDE (PROG)

The first time any touch key is pressed has no effect, but only activates the functions of the buttons themselves and lights up the display.

After 60 seconds of no interaction, the display goes back to the main screen.

 = allows you to CONFIRM

 = allows you to PROGRAM

3.1 - DATE AND TIME SETTING

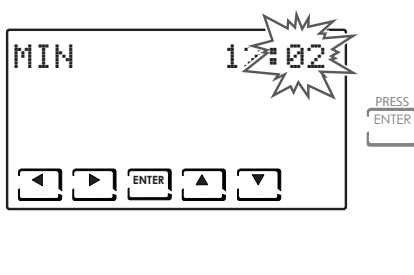
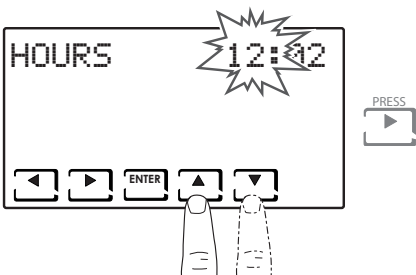
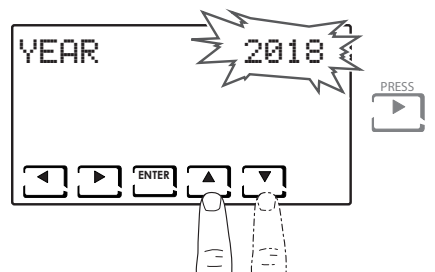
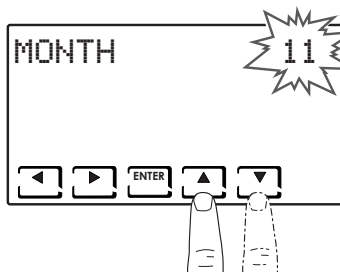
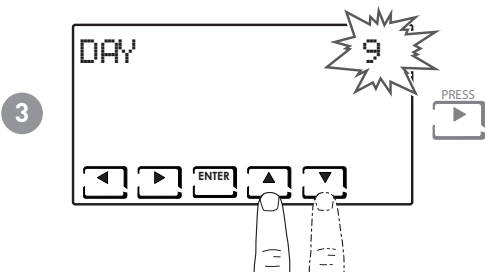
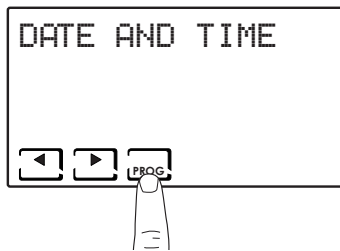
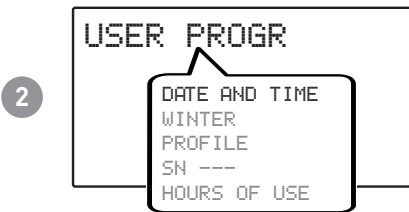
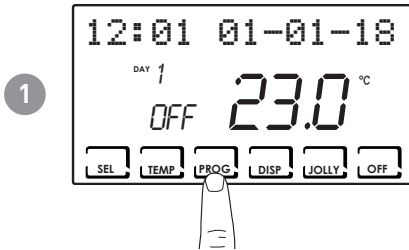

Note: by pressing ◀ always allows you to go back to the previous page.

3.2 - WINTER/SUMMER SETTING

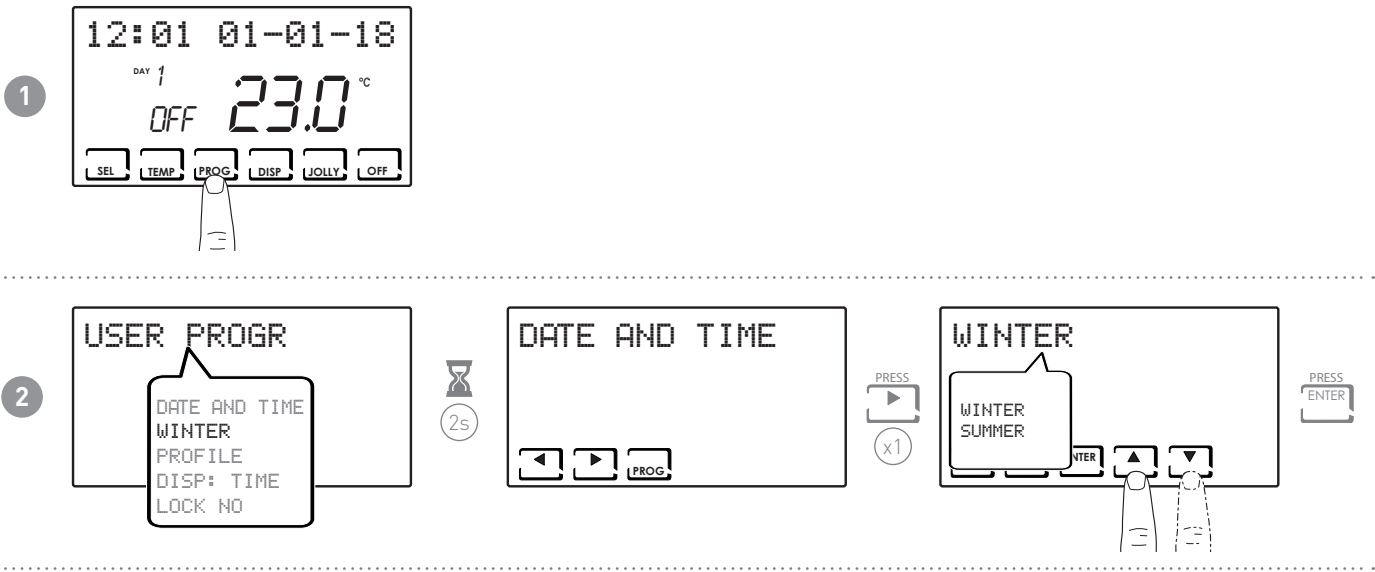

3.3 - HOURLY PROGRAMMING SETTING (PROFILE)

The profiles are set based on whether the WINTER or SUMMER mode was previously selected.

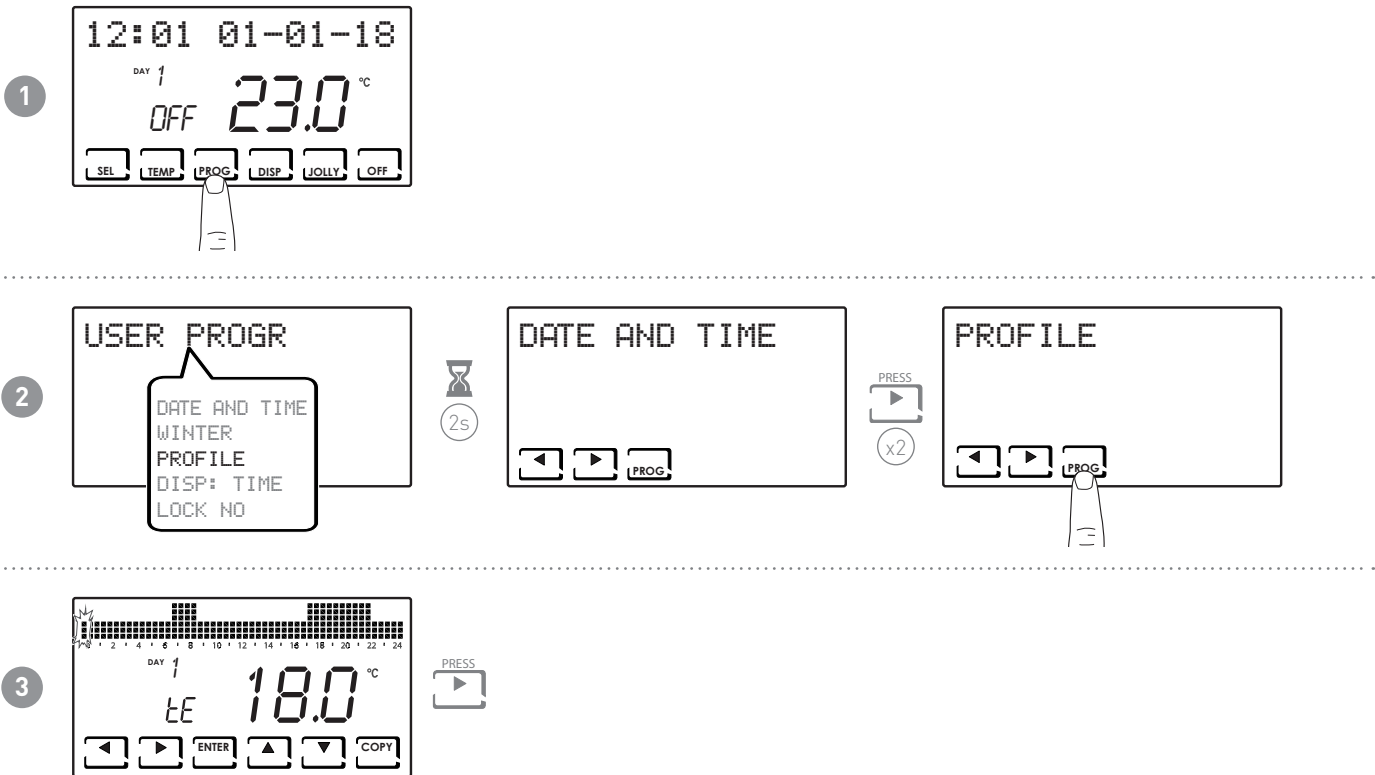

Note: pressing ◀ or ▶ allows you to scroll through the hours.

4

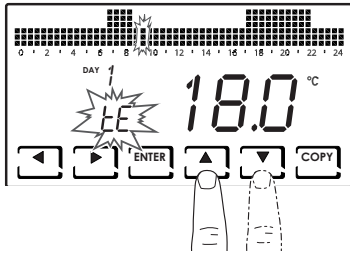

Pressing ▲ or ▼ allows you to select the profile depending on the time.

SETTABLE PROFILES:

- tC (comfort) = SUMMER, WINTER
- tE (economy) = SUMMER, WINTER
- tA (antifreeze) = only for WINTER
- OFF = only for SUMMER

In winter tE < tC; in summer tC < tE.

Note:

- Pressing ENTER to go to the next day.

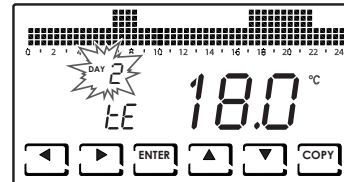
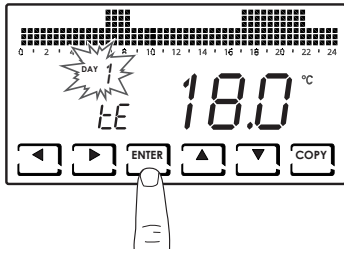

- Pressing COPY allows you to copy the temperature profile displayed to the following day.

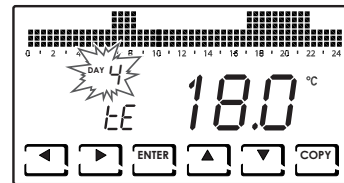
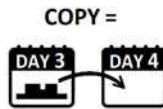
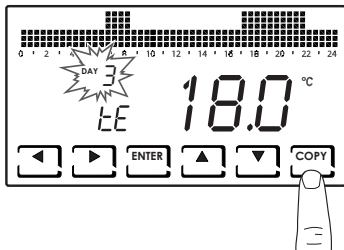

- When you reach DAY H (HOLIDAY), pressing ENTER allows you to exit the sub-function.

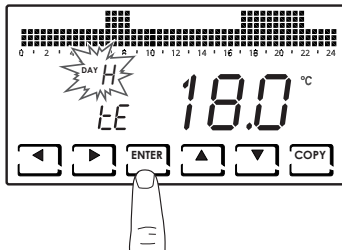

3.4 - SETTING THE DISPLAY

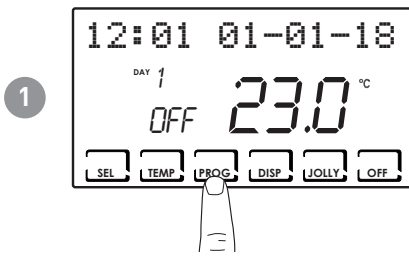

DISPLAYS:

- DISP: HOUR = displays the time on the main bar.

3

- DISP: INFO = displays information on the set operating mode.

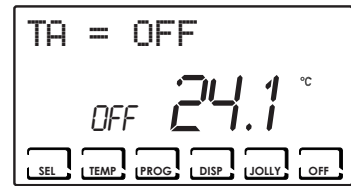
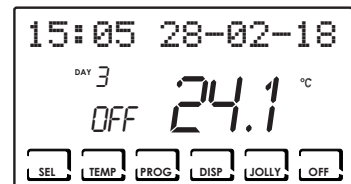

3.5 - SETTING KEYBOARD LOCK WITH PASSWORD

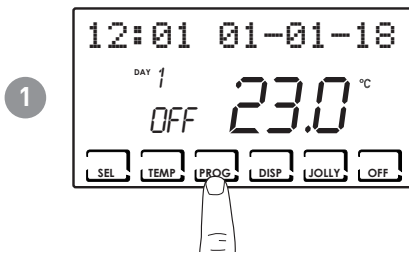

Note: selecting LOCK YES displays the PROG key. Then follow the procedure described in points 3 and 4.

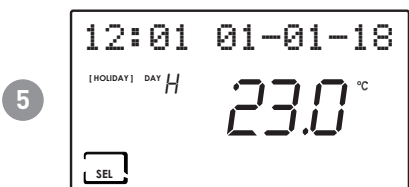
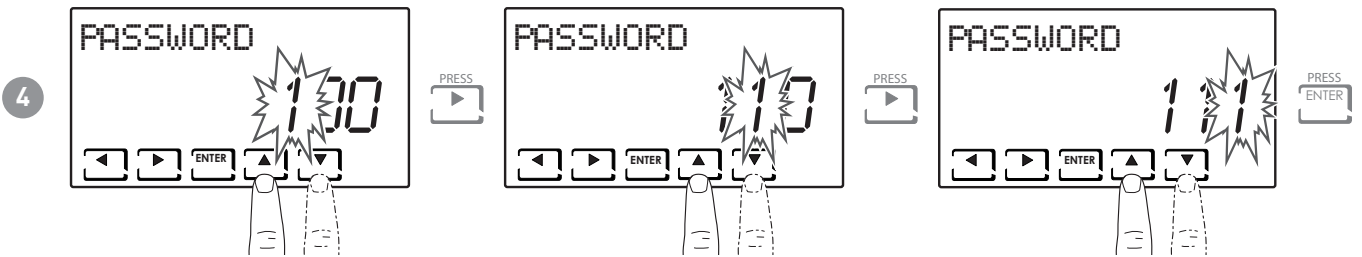
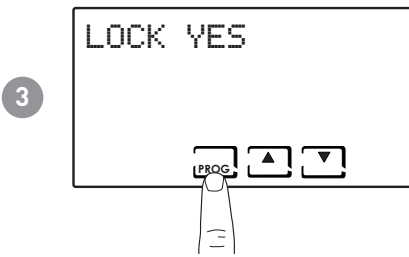

When the keyboard is locked, you can only press the SEL key. Pressing SEL allows you to enter the set password and unlock the keyboard.

4 - OPERATION (SEL)

The CH180WIFI programmable thermostat is a device equipped with a temperature sensor, with an output relay on board, which manages heating and/or air conditioning units.

The LCD display shows you how much energy the entire system consumes through an intuitive graph.

4.1 - OPERATING PROGRAMS

The CH180WIFI programmable thermostat has various operating modes called programs to manage heating/air conditioning.

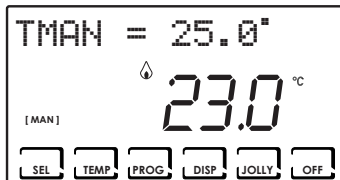

[MAN]

- MANUAL PROGRAM

The device adjusts the room temperature by using a set temperature specified each time, for an unlimited amount of time, until another program is selected.

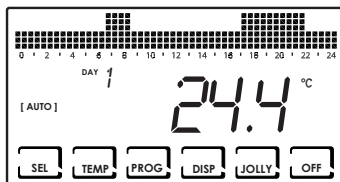

[AUTO]

- WEEKLY PROGRAM

The device manages the set temperatures depending on the hourly programs on a weekly profile. You can set the following temperature levels: tC, tE, tA/OFF (every half hour).

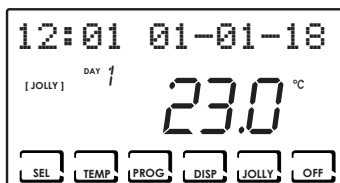

[JOLLY]

- TEMPORARY PROGRAM

The device manages the system by using a temperature that can be set over a variable amount of time (you set the hour and the day up to when you wish to keep the set temperature).

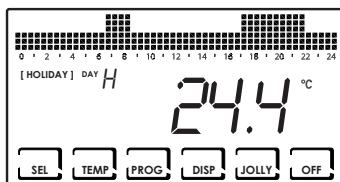

[HOLIDAY]

- HOLIDAY PROGRAM

The device manages the system through an extra daily profile (in the event you are at home for a holiday). You can set the following temperature levels: tC, tE, tA, OFF (every half hour).

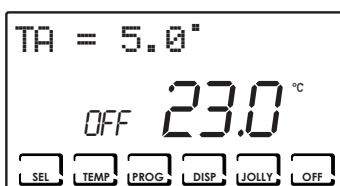

- SYSTEM OFF or ANTIFREEZE PROGRAM

Press the OFF key to switch off the system. During WINTER mode, it maintains the antifreeze temperature.

If you press the OFF key again in SYSTEM OFF mode, it goes back to the previously set operating mode.

4.2 - SELECTING THE OPERATING PROGRAM

The programs are selected by cyclic sequence.

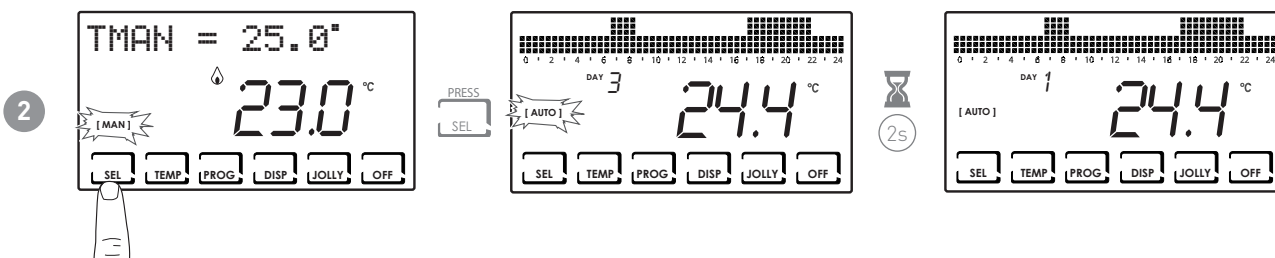
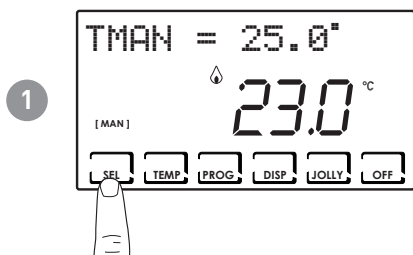

Note: you can select the program from: [MAN] - [AUTO] - [JOLLY] - [HOLIDAY].

DISP Pressing the DISP key allows you to display certain parameters set according to the active operating program.

4.3 - "JOLLY" PROGRAM SETTING

Select JOLLY mode by following the procedure described in the "SELECTING THE OPERATING PROGRAM" paragraph or by pressing JOLLY.

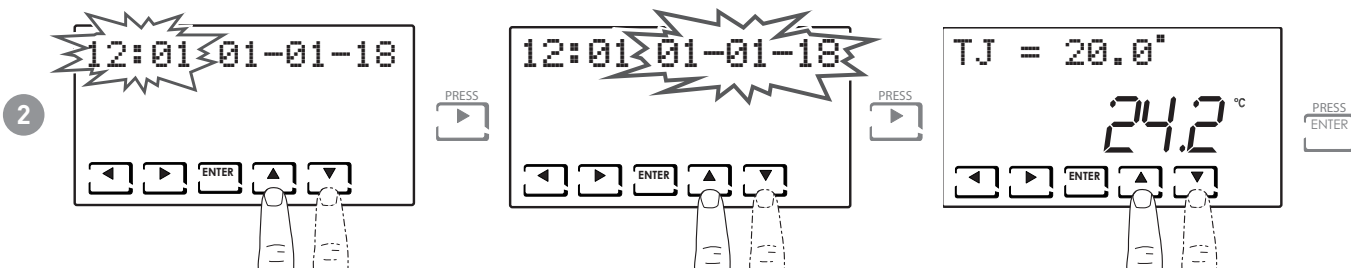

Set the date and time up to when you wish to keep the selected temperature.

At the end of JOLLY mode, the programmable thermostat goes back to the previously set operating mode.

4.4 - SETTING "AUTO" and "HOLIDAY" PROGRAM TEMPERATURE

You can set a tCOMF (comfort temperature) and tECO (economy temperature) temperature value between 2° and 40°C.

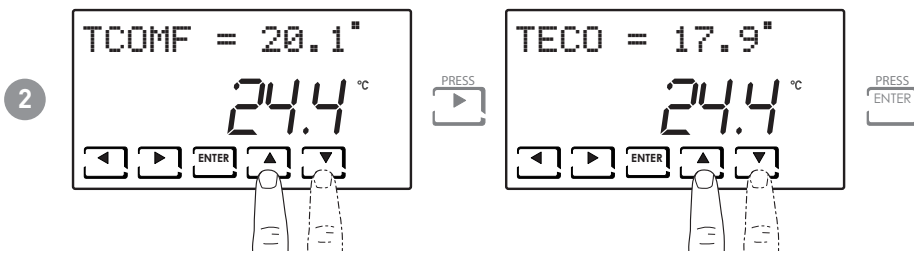
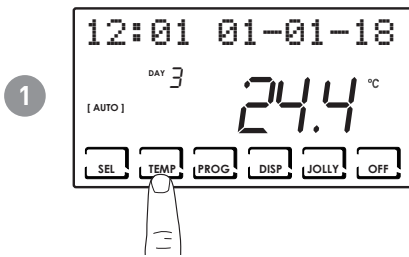

4.5 - SETTING "MANUAL" and "JOLLY" PROGRAM TEMPERATURE

You can set a TMAN and TJ temperature value between 2° and 40°C.

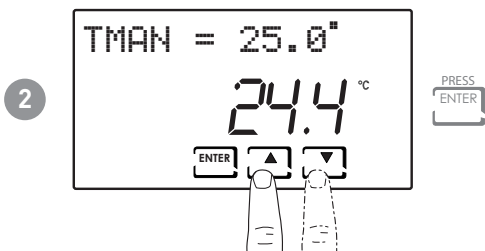
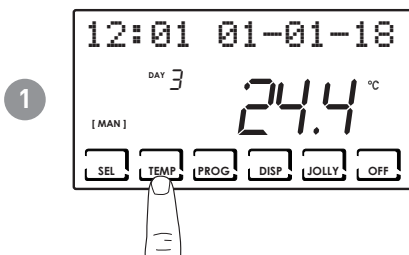

5 - PARAMETER DISPLAY (DISP)

Pressing the DISP key allows you to cyclically view the most important parameters.

5.1 - DATE AND TIME

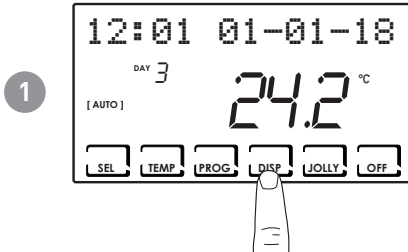

5.2 - SEASON

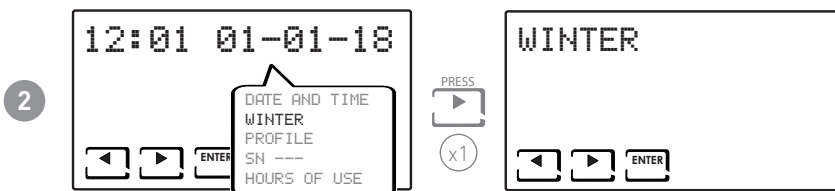
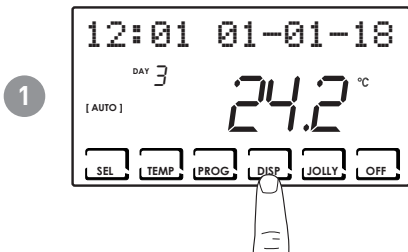

5.3 - PROFILE

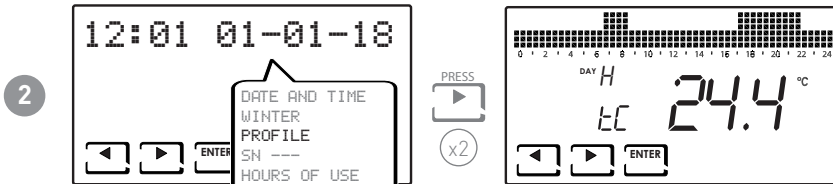
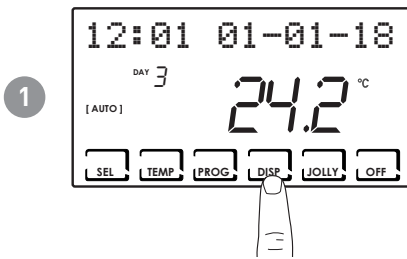

Note: this section is only visible in [AUTO] and [HOLIDAY] mode; in [JOLLY], the display shows the end date and time of the mode.

5.4 - SERIAL NUMBER

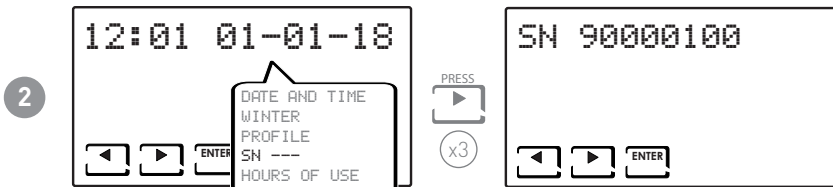
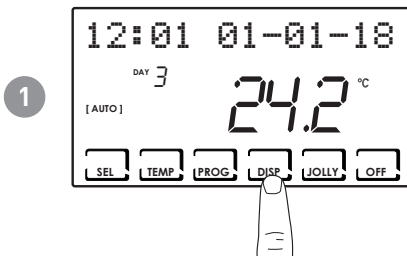

Note: this number identifies the single device and is used for the WiFi activation via the "Intelliclimate+" app.

5.5 - HOURS OF USE

The programmable thermostat records the total consumption of the heating and cooling hours.

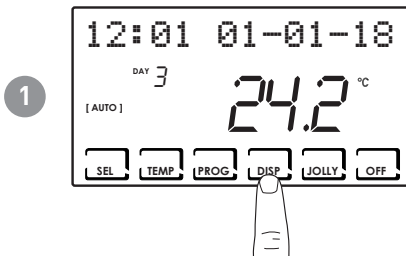

Note: you can display the user statistics for

- PREVIOUS DAY = total operating hours in the previous day
- CURRENT MONTH = total operating hours in the current month
- PREVIOUS MONTH = total operating hours in the previous month
- CURRENT YEAR = total operating hours in the current year
- TMAX = maximum room temperature measured the previous day
- TMIN = minimum room temperature measured the previous day
- RESET

Pressing DISP on the CURRENT MONTH, PREVIOUS MONTH, and CURRENT YEAR screens displays a graph with details on use (shown below).

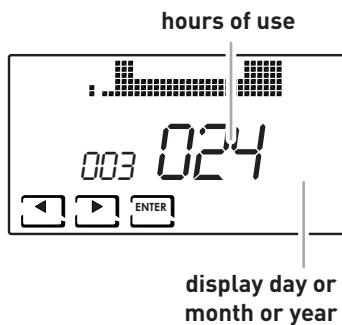

Pressing ◀ or ▶ allows you to scroll through and display the day of the month (or the month or year, depending on the page being displayed) and the hours of use.

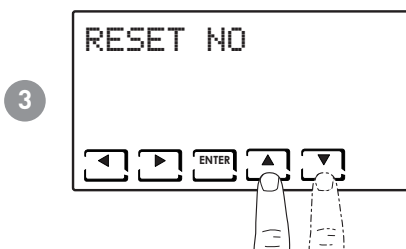

Note: select RESET YES to reset the use statistics.

6 - ADVANCED FUNCTIONS (PROG)

To access ADVANCED PROGRAMMING, hold down the PROG key for a few seconds.

6.1 - SECONDS DISPLAY STAYS ON

Allows you to adjust the display's backlight (sky blue light) with a duration that can be programmed between 5 and 30 seconds.

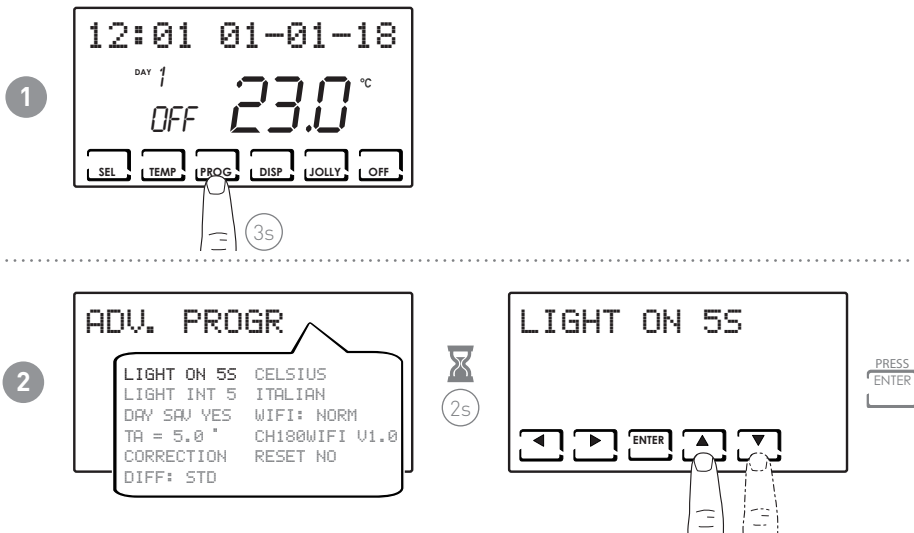

6.2 - DISPLAY LIGHTING INTENSITY

Allows you to modify the luminous intensity of the display, at 10 levels + 0 Off.

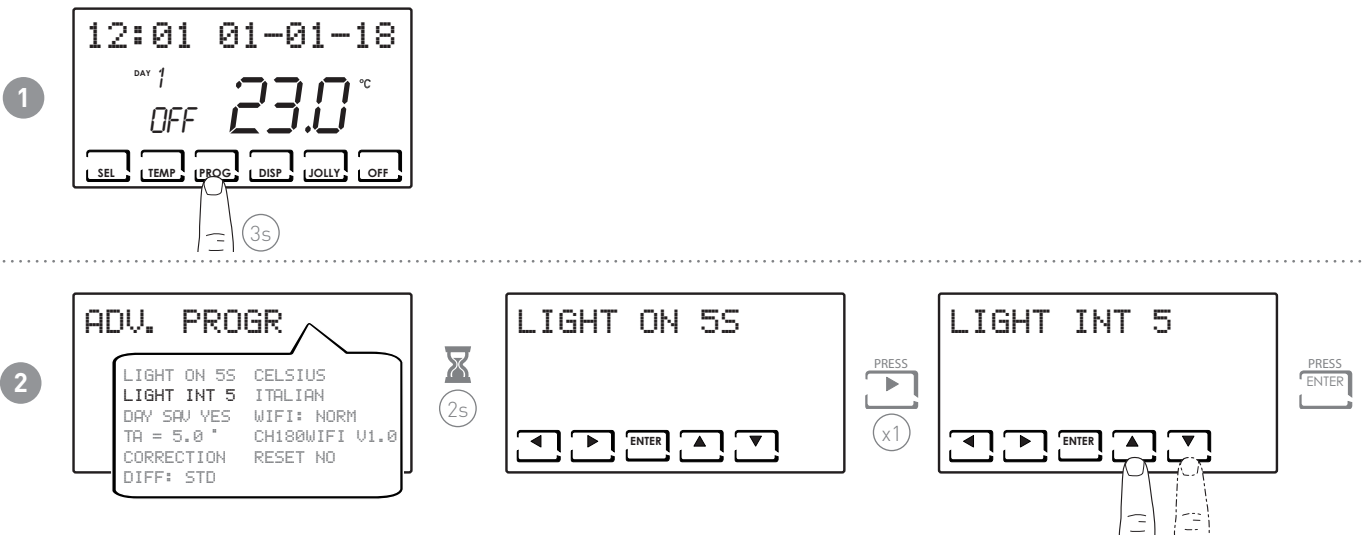

6.3 - DAYLIGHT SAVING TIME

Automatically selects daylight saving time, applicable in Europe and some other countries. This set-up automatically updates the time when it changes (March and October) (default = YES).

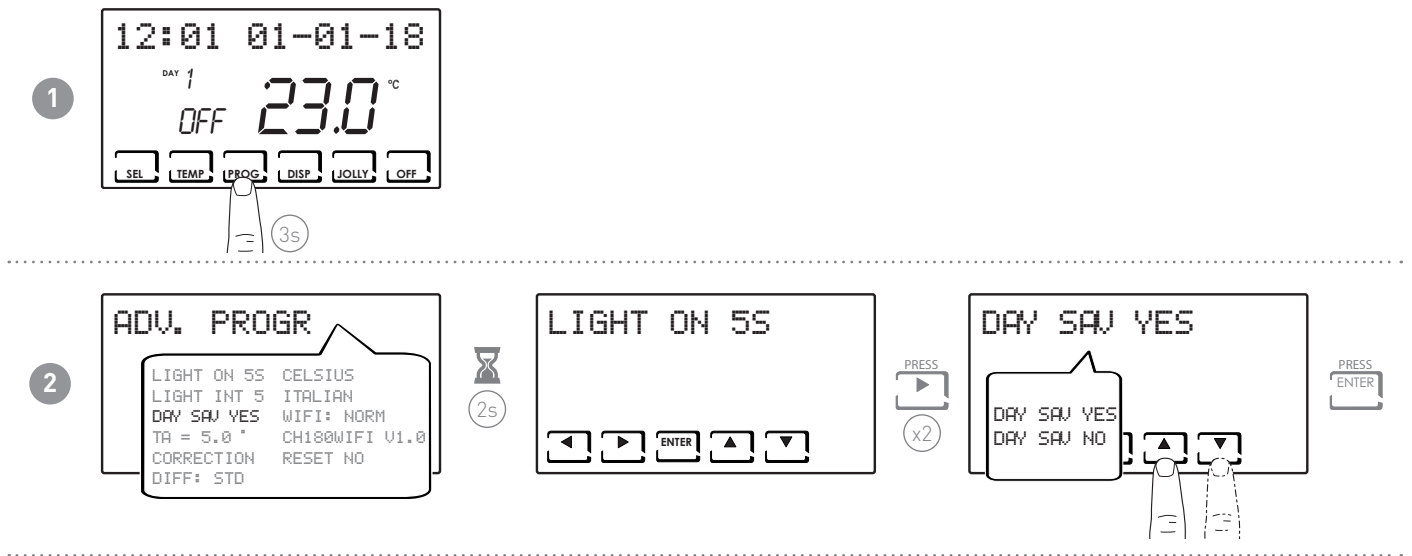

6.4 - ANTIFREEZE TEMPERATURE

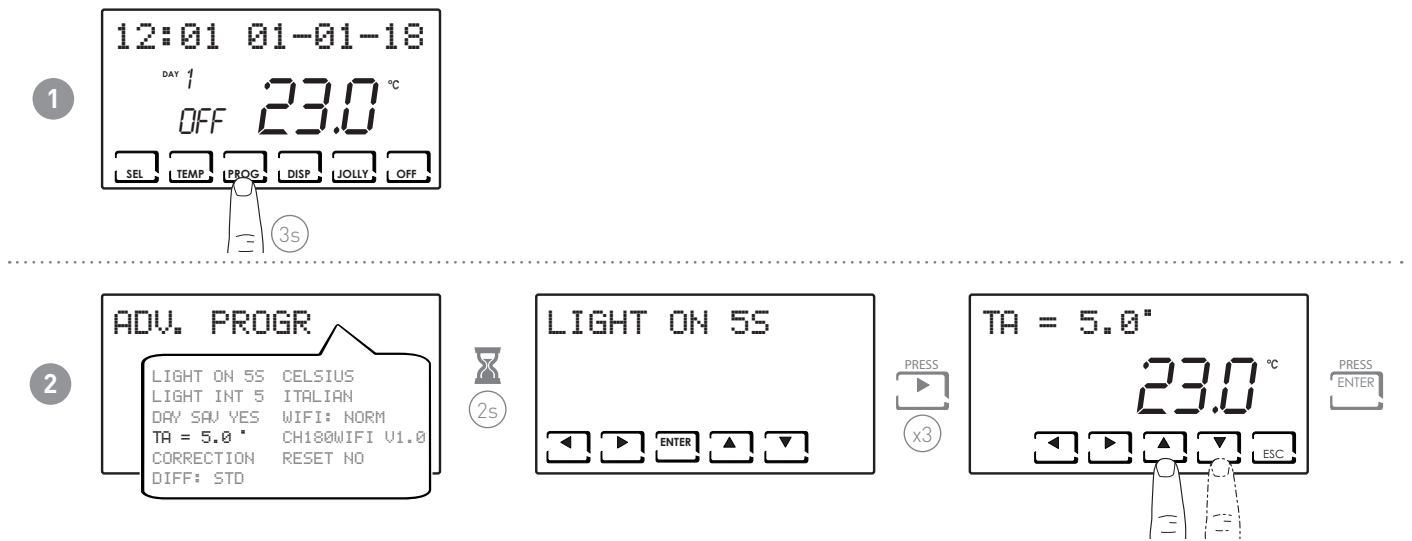

Note:

- the tA that can be set is between 2.0 and 7.0°C or OFF.

6.5 - ROOM TEMPERATURE CORRECTION

This allows you to modify the read temperature, which, due to the recessed wall installation or perhaps a non-ideal height, might not indicate the true temperature perceived.

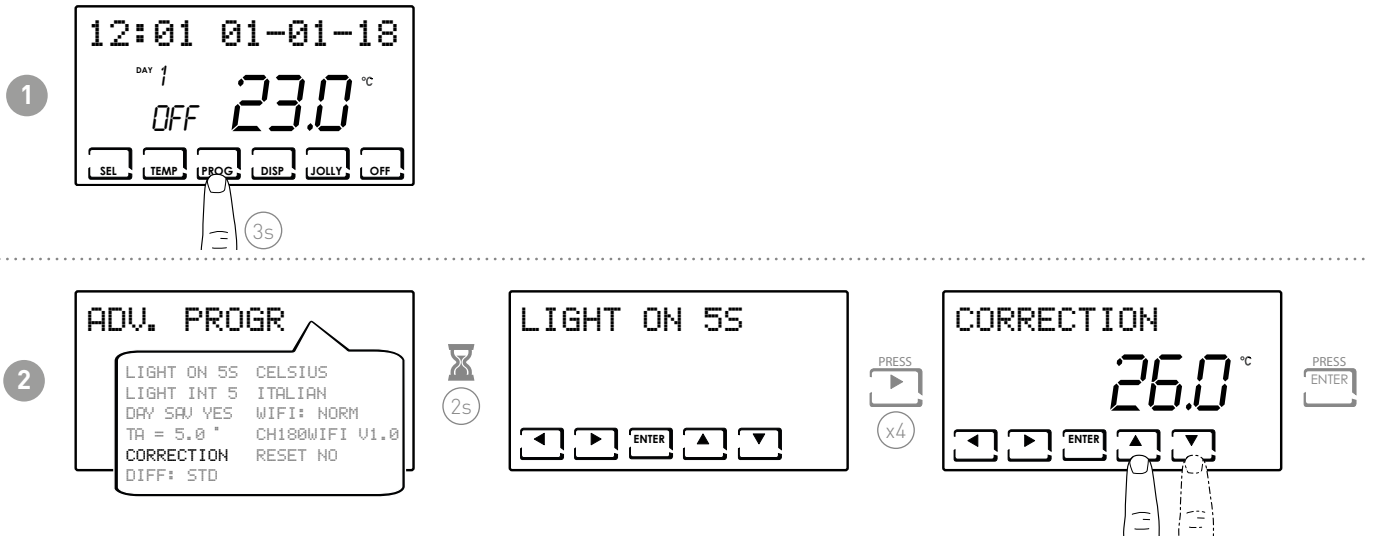

Note:

- the tA that can be set is between -5.0 and +5.0°C or OFF.

6.6 - DIFFERENTIAL MANAGEMENT

It allows the temperature difference between the OFF and ON status to be managed.

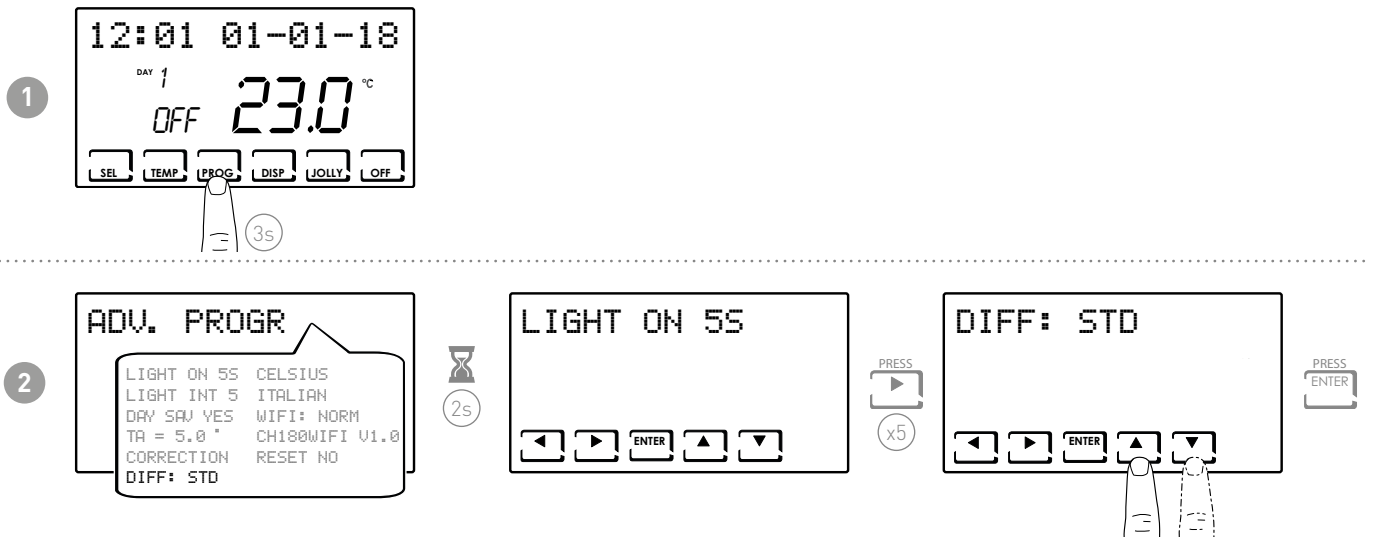

Note: the differential value that can be set is between 0.3 and 5.0, or STD (default = STD).

6.7 - CELSIUS / FAHRENHEIT

This allows you to choose the temperature display scale between Celsius and Fahrenheit degrees.

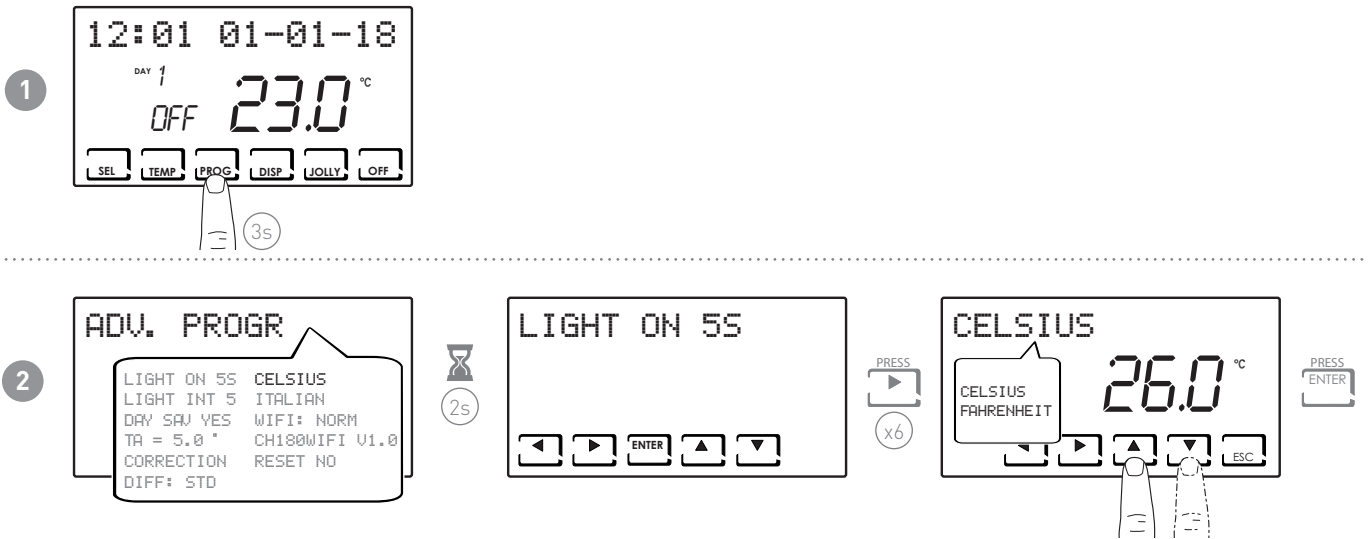

Note: the default setting is Celsius.

6.8 - LANGUAGE SELECTION

Allows you to change the language used during programming.

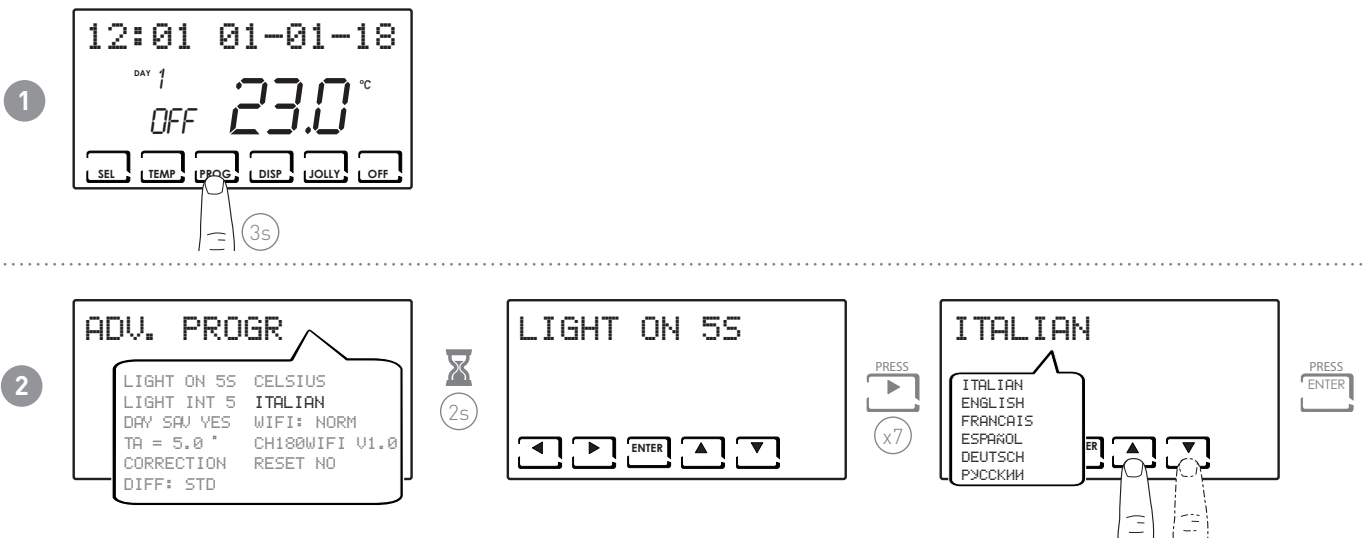

Note: the default setting is Italian.

6.9 - WIFI

This displays the WiFi connection status of the device.

1

2

- --- = off
- NORM. = normal
- A.P. = access point (allows you to connect the smartphone)

6.10 - INFORMATION

Displays the software version of the programmable thermostat.

1

2

6.11 - RESETTING DEFAULT PARAMETERS

This allows you to reset all the parameters (except date and time) to the factory settings.

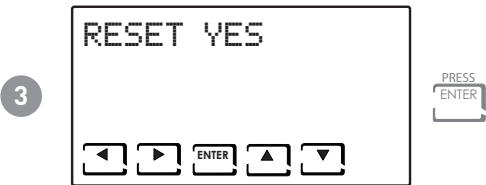
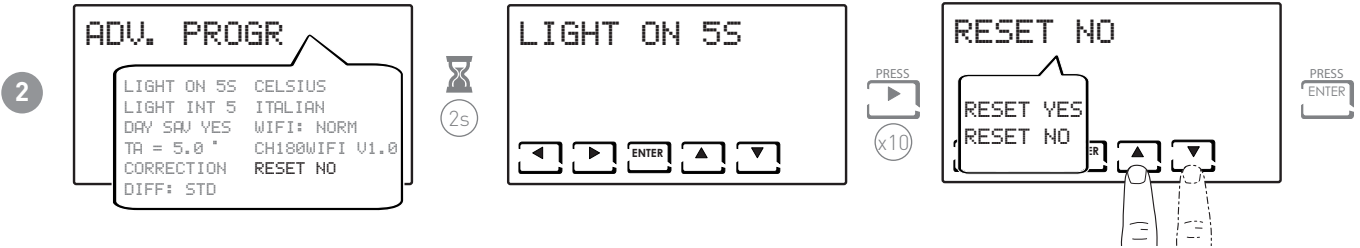
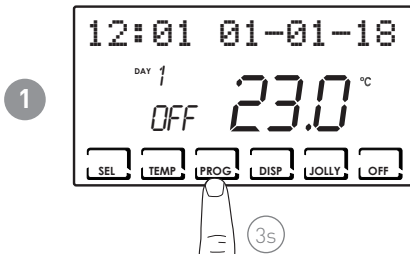

7 - REMOTE PROGRAMMING VIA APP

The WIFI signal in the programmable thermostat allows the device to be remote-controlled via the **IntelliClima+** APP, available free of charge on Google Play Store and Apple App Store.



IntelliClima+



7.1 - WIFI ACTIVATION

When switched on for the first time, the programmable thermostat has the WiFi connection off. Activate it by accessing **ADVANCED PROGRAMMING** and following the instructions.

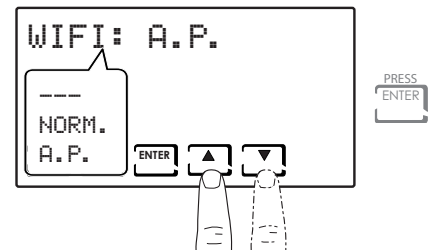
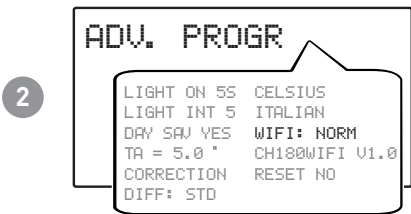
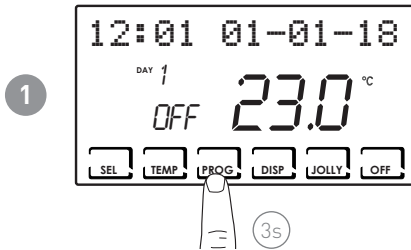

- --- = off
- NORM. = normal
- A.P. = access point (allows you to connect the smartphone)

Select A.P. and press ENTER.

Start the installation wizard in the APP as described in the "INSTALLATION PROCEDURE" paragraph.

7.2 - INSTALLATION PROCEDURE



1

The first screenshot shows the app's login screen with fields for Username and Password, a LOGIN button, a NOT YET REGISTERED? button, and a GSM Mode checkbox. The second screenshot shows the registration form with fields for Username, Password, Confirm password, Email address, First name, and Last name.

Install the APP and when first activated, create an account by entering the user name and password.

2

The first screenshot shows a 'No house available' message with a plus icon. The second screenshot shows the 'GENERAL SETTINGS' menu with options like ADD HOUSE, ADD THERMOSTAT, SERVICE ADD, etc. The third screenshot shows the 'ADD HOUSE' dialog box with a Name field and a CONFIRM button.

Create a new home by pressing ; enter the name and press .

3

The first screenshot shows the 'ADD THERMOSTAT' screen with a plus icon. The second screenshot shows a list of available thermostat models: CH193WIFI, CH180WIFI, CH180RFWIFI, CH180WIFI LITE, CH140GSM2, and CT3MA.

Add the programmable thermostat by pressing  and select CH180WIFI.

4



The screenshot shows the 'My home' screen with a thermostat display showing 27.3° and a 'Summer home' section below it.

At the end of the procedure, the new programmable thermostat is displayed inside the home.

7.3 - WIFI STATUS

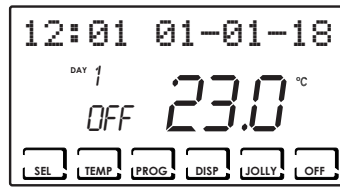
The antenna  allows you to display the quality of the WiFi signal.



EXCELLENT signal	GOOD signal	POOR signal
		

If the  icon is:

- ON STEADY = status is OK
- FLASHING ON = the device cannot find the server
- OFF = the device is not connected to the router (OFF appears on the display).

8 - DISPOSAL



The symbol of the crossed-out wheeled bin indicates that the products must be collected and disposed of separately from household waste. The batteries and integrated accumulators may be disposed of together with the product. They will be separated at the recycling facilities. A black bar indicates that the product was placed on the market after 13 August 2005. Participating in the separate collection of products and batteries contributes to the correct disposal of these materials and therefore avoids possible negative consequences for the environment and human health. For more detailed information on the collection and recycling programmes available in your country, contact the local authorities or the sales point where you purchased the product.

9 - GENERAL WARRANTY CONDITIONS

The conventional warranty lasts 24 months, starting from the date the equipment is installed. The warranty covers all parts of the equipment, with the exception of those subjected to normal wear

EAC CE

EN79902A - 01/2019



FANTINI COSMI S.p.A.
Via dell'Osio, 6 20090 Caleppio di Settala, Milan – ITALY
Tel. +39 02 956821 | Fax +39 02 95307006 | info@fantinicosmi.it
www.fantinicosmi.it