

THREE-POLE CONTACTORS series HR33-HR55 up to 30 kW

USE

Series HR contactors are particularly suitable for controlling motors, heating elements and three-phase and single-phase loads in general.

OPERATION AND INSTALLATION

Screw mounting, distance between centres for fixing to EN 50003 or snap fitted onto 35 mm metal rail EN50022-3 DIN 46277-3

N.B. for cables with a section above 2x10mm² only use screw fixing

Mounting tilt not exceeding ± 30° in relation to the vertical

Ambient temperature from -5°C to 40°C

Altitude up to 2,000 metres

Relative humidity not exceeding 50% at 40°C

STANDARDS AND APPROVALS

Compliance with recommendations and standards:

IEC 947-4, CEI EN 60947-1, CEI EN 60947-4-1, VDE 0660, BS 60947-4-1, UTE - NCF 63-110, NEMA NBN C63158, AS1029

APPROVALS:

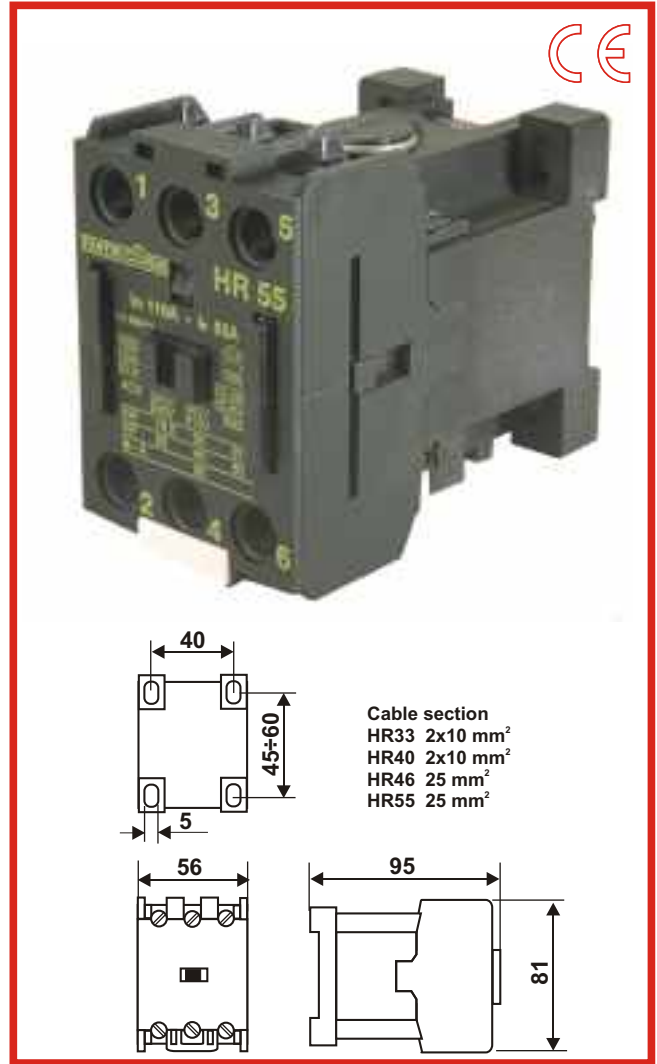

Control coil codes (IH25)

Code	F	G	D	U	X	C	W	B	Z
50 Hz -V	24	48	110 to 115	220 to 230	220 to 240	366	380 to 400	440	480 to 500
60 Hz -V	58					440		528	

TYPE	Contact diagram	Rated thermal current I _{th}	Rated current in AC3 380V I _e	Controllable powers of three-phase motors in category AC2-AC3				Unit weight Kg.	Packs of No
				220-240V~	380-415V~	440V~	660V~		
HR33N		72 A	33A	7.5 kW 10 HP	15 kW 20 HP	18.5 kW 25 HP	22 kW 30 HP		
HR40N		72 A	40A	11 kW 15 HP	18.5 kW 25 HP	20 kW 27 HP	30 kW 40 HP		
HR46N		90A	46A	15 kW 20 HP	22 kW 30 HP	25 kW 34 HP	37 kW 50 HP		
HR55N		110A	55A	18.5 kW 25 HP	30 kW 40 HP	33 kW 45 HP	35 kW 60 HP		

ACCESSORIES

- Instantaneous auxiliary contacts.....**IR..**
- Time-delayed auxiliary contacts.....**IT..**
- Auxiliary contacts for d.c. control.....**IDC..**
- Mechanical interlock.....**I82**
- Thermal relay.....**JA46**



SPARE PARTS

Coils**IH25**

Add code of voltage required to code (see control coil codes indicated above)

- Power pole for HR33, complete with 1 portable contact + 2 fixed contacts**polo HR33**
- Power pole for HR40, complete with 1 portable contact + 2 fixed contacts.....**polo HR40**
- Power pole for HR46, complete with 1 portable contact + 2 fixed contacts.....**polo HR46**
- Power pole for HR55, complete with 1 portable contact + 2 fixed contacts.....**polo HR55**

TECHNICAL SPECIFICATIONS CONTACTORS series HR33-HR55

CONTACTORS type:				HR33	HR40	HR46	HR55
Rated insulation voltage	IEC	Ui	V ~	660	660	660	660
Rated thermal voltage	IEC	Ith	A	72	72	90	110
Rated operating current at 380V~ in AC-1 - Ie			A	64	64	80	100
Rated operating current at 380V~ in AC-3 - Ie			A	33	40	46	55
Electric life in AC-3				see graph	see graph		
Mechanical life	(cl.IV 1200man/h)		millions of cycles	10		10	1010
CONTROLLABLE POWERS IN OPERATING CATEGORY THREE-PHASE		220 - 240 V~	kW (HP)	7.5(10)	11 (15)	15 (10)	18.5(15)
AC-3 IEC 947-4-1CEI EN 60947-4-1		380 - 415V~	kW (HP)	15 (20)	18.5 (25)	22 (30)	30 (40)
		500V~	kW (HP)	20 (27)	22 (30)	30 (37)	37 (50)
CONTROLLABLE POWERS according to standards		120V~	HP	5	7.5	10	15
		220 - 240 V~	HP	10	15	20	25
		440 - 480 V~	HP	20	25	30	40
		550 - 600 V~	HP	25	30	40	40
Rated operating current at 600V~		Ie	A	40	50	70	90
CONTROLLABLE POWERS according to standards		120V~	HP	5	7,5	10	15
 LISTED 24932		220 - 240 V~	HP	10	15	20	25
		440 - 480 V~	HP	20	25	30	40
		550 - 600 V~	HP	25	30	40	40
Rated operating current at 600V~		Ie	A	40	50	70	90

CONTROL COIL

Alternating current absorption	inrush	VA	90
	sealed	VA	9
Direct current absorption	inrush	W	130
	sealed	W	8
Minimum and maximum supply voltage	Un	V	from 0.85 to 1.1 V
Switching times at rated voltage	inrush	ms	20to25
	sealed	ms	15to20
Coil insulation	Class		F

H

1 3 5 13
A1
2 4 6 14
A2

THREE-POLE CONTACTORS HR - electric life

Diagram of the electric life of contacts as a function of the operating current

Category AC-1

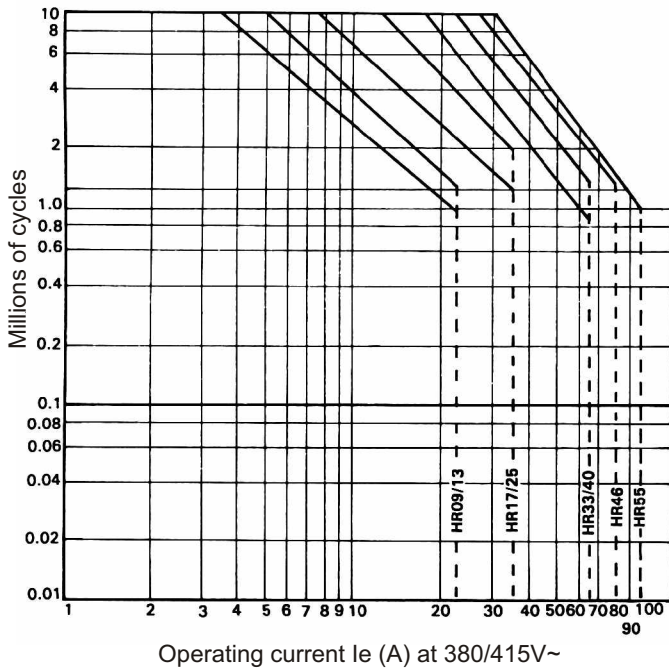

Category AC-2

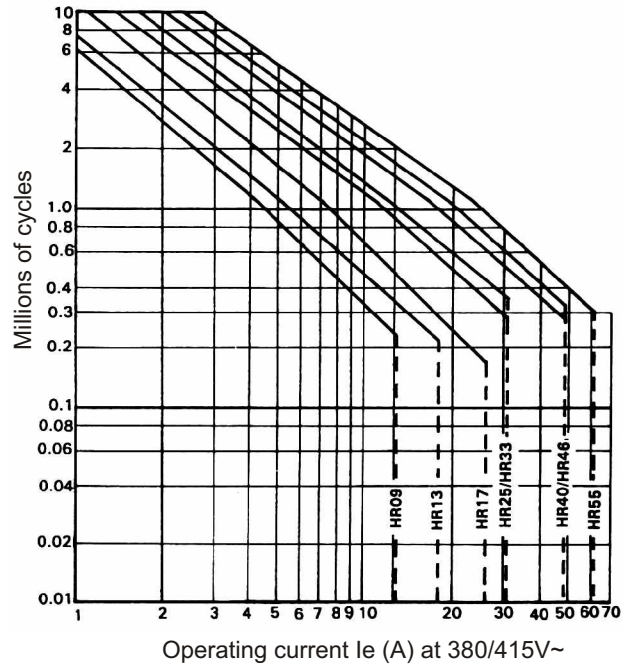

Category AC-3

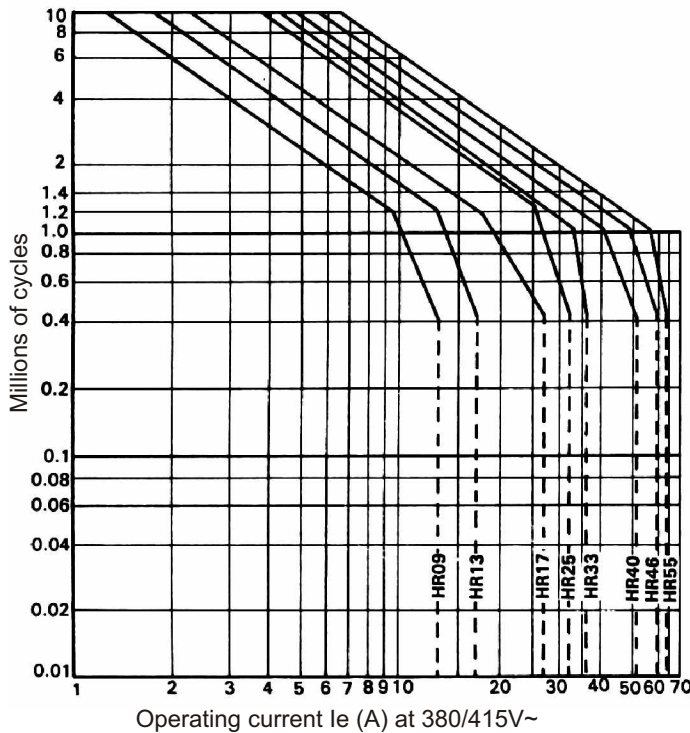

Category AC-4

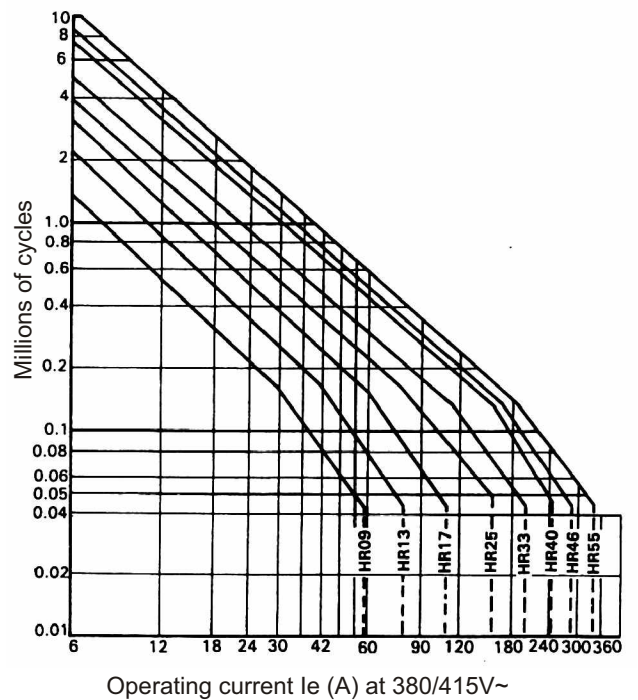

ACCESSORIES FOR CONTACTORS SERIES HR

INSTANTANEOUS AUXILIARY CONTACT BLOCKS to fix to the top of the contactors



TYPE	Contacts diagram	Rated thermal current I _{th}	Rated current I _e AC-15 EN 60947-5-1 IEC947-5-1		
			220V 240V	380V 415V	500V
IR02		10 A	3 A	1.5 A	1 A
IR11					
IR22					
IR13					
IR31					

TIME-DELAYED AUXILIARY CONTACT BLOCKS to fix to the top of the contactors



TYPE	Contacts diagram	Timed delay:	Rated insulation voltage U _i	Rated thermal current I _{th}	Rated current I _e AC-15		
					220V 230V	380V 415V	500V
IT60D		3-50 sec. From energising	690V	10 A	6 A	6 A	3 A
IT60I		3-50 sec. From de-energising					

AUXILIARY CONTACT BLOCKS FOR DIRECT CURRENT CONTROL OF CONTACTORS WITH ALTERNATING CURRENT COIL to fix to the top of contactors, complete with saving resistance and delayed NO contact. One normally open NO (DC 10) or NC (IDC01) contact remains available.



F	G	D	U	ADDITIONAL CODE
24V	48V	110V	230V	Coil voltage in a.c.

TYPE	Contact diagram	Rated thermal current I _{th}	Rated current I _e AC-11		
			220V 240V	380V 415V	500V
IDC10 <input type="checkbox"/>		10 A	3 A	1.5 A	1 A
IDC01 <input type="checkbox"/>					



MECHANICAL INTERLOCK side mounting

I85	Prevents two contactors, even of different sizes, from closing simultaneously
------------	---



WATERPROOF INSULATING ENCLOSURES IP65

UH13Y	With blind cover and reset button standard, for contactors HR09-HR13 and direct starters HS09Y - HS13Y
UH25Y	With blind cover and reset button standard, for contactors HR17-HR25 and direct starters HS17Y - HS25Y
UH13YP	With run-stop/reset buttons for direct starters HS09Y..P - HS13Y..P
UH25YP	With run-stop/reset buttons for direct starters HS17Y..P - HS25Y..P

THERMAL RELAY FOR CONTACTORS HR33-HR40-HR46-HR55

USE

For protection against overloads of three-phase users. For single-phase loads, connect two poles of the thermal relay in series to obtain heating of three bimetals.

SPECIFICATIONS

- Direct mounting on HR contactors
- Automatic compensation of ambient temperature
- Protection against phase failure
- Auxiliary contacts 1 NO + 1 NC
- Manual reset
- Stop/reset button
- Trip indicator and release test
- Operating temperature from -5°C to +55°C
- Storage temperature from -40°C to +70°C
- Relative Humidity from 45 to 85%

STANDARDS AND APPROVALS

VDE 0660 CEI EN 60947-4-1 IEC 947-4-1

Approval:

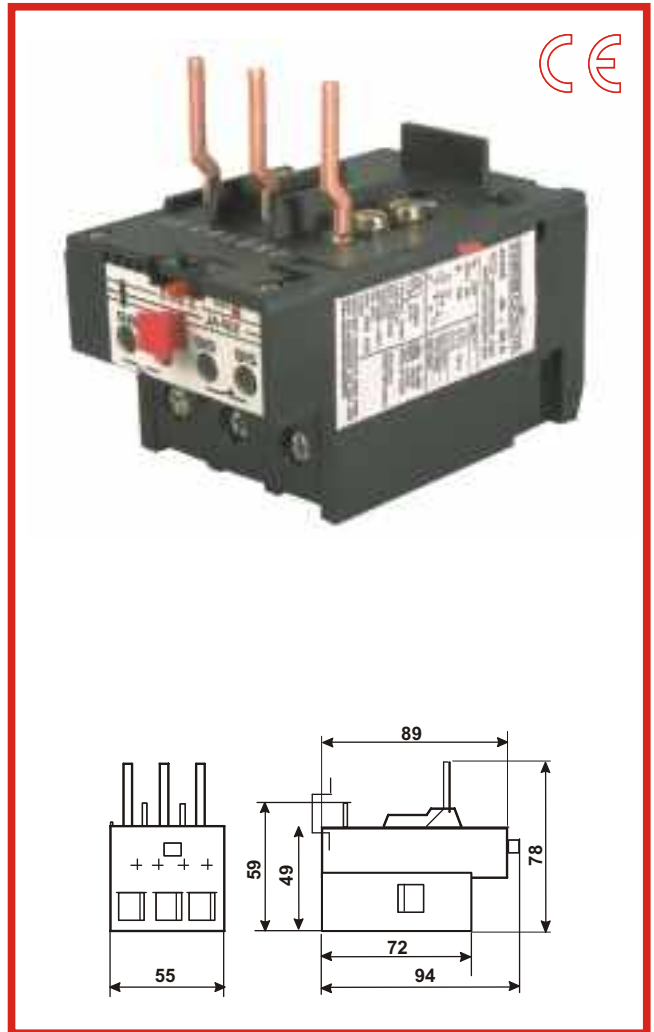

SELECTION TABLE

REGULATION SCALE CODES	PROTECTION FUSES(A)	
	aM	gI
A 14 to 23	25	50
B 20 to 33	40	63
C 28 to 42	50	80
D 35 to 50	63	100
E 46 to 65	80	100

TYPE <input type="checkbox"/>	Regulation scale	Terminal diagram and numbering	Rated thermal current I _{th}	Contact specifications			Vd.c.	Unit weight	Packs of No
				Rated current I _e 220V 240V	Va.c. 380V 415V	500V			
JA46 <input type="checkbox"/>	A From 14 at 65 (see selection table)		10 A	6 A	3 A	1.5 A	100		

ACCESSORIES FOR THERMAL RELAYS JA25



SUPPORT FOR SEPARATE MOUNTING OF THERMAL RELAY JA25

I82

Support with terminal block to install the thermal relay separately from the contactor. May be fixed to the base plate or 35 mm rail EN 50022-3 DIN 46277-3

TECHNICAL SPECIFICATIONS THERMAL RELAYS JA25 - Ja46

THERMAL RELAY type:			JA25	JA46
Rated insulation voltage	Ui	V~	660	660
Admissible ambient temperature	°C		-25 to 50	-20 to 60
Temperature compensation	°C		-5 to 50	-20 to 60
Maximum humidity	%RH		95% a 40°C	95% a 40°C
Reset			manual and automatic	manual and automatic
Trigger simulation button			yes	yes
Auxiliary contacts			1NO + 1NC	1NO+1NC
Rated thermal current a.c.	Ith	A	10	10
RATED OPERATING CURRENT IN CATEGORY	Va.c.	220/240V ~ A	3	6
		380/415V ~ A	1.5	3
	Vd.c.	500V ~ A	1	1.5
		W	50	100

SELECTION TABLE FOR THERMAL RELAYS JA25 - Ja46

N.B. The absorption values are indicative and relate to direct starting three-phase motors.
To select thermal relay calibration and fuse value, refer to the ratings plate of the motor.
For high switching frequency it is advisable to select the contactor with higher power.

																								RECOMMENDED CONTACTOR						
																								↓	THERMAL RELAY CALIBRATION		FUSES			
																										aM	gl			
220V			240V			380V			415V			440V			500V			600V			660V									
KW	HP	A	KW	HP	A	KW	HP	A	KW	HP	A	KW	HP	A	KW	HP	A	KW	HP	A	KW	HP	A							
						0.06	0.08	0.22				0.06	0.08	0.19	0.06	0.08	0.16	0.09	0.12	0.21	0.09	0.12	0.19			JA25A 0.15to 0.25	0.5	-		
															0.09	0.12	0.24										JA25A 0.15to 0.25	0.5	-	
																											JA25B 0.22to 0.33	0.5	-	
												0.09	0.12	0.28				0.12	0.16	0.27	0.12	0.16	0.25			JA25B 0.22to 0.33	0.5	-		
						0.09	0.12	0.33							0.12	0.16	0.33										JA25C 0.3 to 0.45	1	2	
0.06	0.08	0.38	0.06	0.08	0.35							0.12	0.16	0.37				0.18	0.24	0.4	0.18	0.24	0.35			JA25C 0.3 to 0.45	1	2		
						0.12	0.16	0.42																			JA25C 0.3 to 0.45	1	2	
															0.18	0.24	0.55	0.18	0.24	0.46	0.25	0.34	0.55			JA25D 0.42to 0.63	1	2		
															0.25	0.34	0.6	0.25	0.34	0.5	0.37	0.46	0.55			JA25D 0.42to 0.63	1	2		
0.09	0.12	0.55	0.09	0.12	0.5							0.18	0.24	0.55	0.18	0.24	0.55	0.18	0.24	0.46	0.25	0.34	0.55			JA25E 0.6 to 0.9	2	0.12		
															0.25	0.34	0.8	0.25	0.34	0.5	0.37	0.46	0.55			JA25E 0.6 to 0.9	2	4		
						0.25	0.34	0.8							0.37	0.5	0.9	0.37	0.5	0.9	0.55	0.75	0.9			JA25F 0.85to 1.27	2	0.18		
0.24	1.10	0.18	0.24	1							0.37	0.5	1.06				0.55	0.75	1	0.75	1	1.1			JA25F 0.85to 1.27	2	4			
						0.37	0.5	1.2				0.55	0.75	1.25	0.55	0.75	1.2	0.75	1	1.2						JA25F 0.85to 1.27	2	4		
0.25	0.34	1.4	0.25	0.34	1.38	0.55	0.75	1.5				0.75	1	1.65	0.75	1	1.5	1.1	1.5	1.65	1.1	1.5	1.5			JA25G 1.2 to 1.75	2	4		
0.37	0.5	2	0.37	0.5	1.9	0.75	1	2	0.75	1	2	1.1	1.5	2.3	1.1	1.5	2	1.5	2	2.2	1.5	2	2			JA25G 1.2 to 1.75	2	4		
						1.1	1.5	2.6	1.1	1.5	2.5				1.5	2	2.6										JA25H 1.7 to 2.6	4	6	
																											JA25H 1.7 to 2.6	4	6	
0.55	0.75	2.7	0.75	1	3	1.5	2	3.5	1.5	2	3.5	1.5	2	3.1				2.2	3	3.1	2.2	3	2.9			JA25I 2.5 to 3.7	6	10		
0.75	1	3.3																			3	4	3.5			JA25I 2.5 to 3.7	6	10		
1.1	1.5	4.5	1.1	1.5	4	2.2	3	5	2.2	3	5	2.2	3	4.3	2.2	3	3.8	3	4	4.2	4	5.5	4.9			JA25L 3.6 to 5.4	8	16		
															3	4	5										JA25L 3.6 to 5.4	8	16	
																											JA25M 5.3 to 7.5	10	20	
1.5	2	6	1.5	2	5.5	3	4	6.6	3	4	6.5	3	4	5.8	4	5.5	6.5	4	5.5	5.5	5.5	5.7	6.7			JA25M 5.3 to 7.5	10	20		
																			5.5	7.5	7.5						JA25M 5.3 to 7.5	10	20	
																											JA25N 7.3 to 10.2	12	20	
2.2	3	8.7	2.2	3	7.9	4	5.5	8.5	4	5.5	8.5	4	5.5	7.6	5.5	7.5	9				7.5	10	9			JA25N 7.3 to 10.2	12	20		
																											JA25N 7.3 to 10.2	12	20	
																											JA25O 10 to 15	16	25	
3	4	11.5	3	4	10.5	5.5	7.5	11.5	5.5	7.5	11	5.5	7.5	10.3	7.5	10	12				11	15	13			HR13 JA25O 10 to 15	16	25		
			4	5.5	14				7.5	10	14	7.5	10	13.5				11	15	14						HR13 HR17				
4	5.5	15	5.5	7.5	19	7.5	10	15.5				11	15	19	11	15	17	15	20	19	15	20	17.5			HR17 HR25	JA25P 13.5 to 20	25	50	
5.5	7.5	21	7.5	10	24.5	11	15	22	11	15	21				15	20	23	18.5	25	23.5	18.5	25	21			HR25	JA25Q 18 to 26	40	63	
																											HR33	JA46B 20 to 33	40	63
7.5	10	27				15	20	30	15	20	28	15	20	26	18.5	25	28	22	30	27	22	30	25			HR33	JA46C 28 to 42	50	80	
			11	15	35				18.5	25	35	18.5	25	32	22	30	33	30	40	37	30	40	33			HR40				
11	15	39				18.5	25	37				22	30	37													HR40	JA46C 28 to 42	50	80
						22	30	44	22	30	40											37	50	42			HR46	JA46D 35 to 50	63	100
			15	20	48							30	40	50	30	40	44	37	50	45	45	60	49			HR55	JA46E 46 to 65	80	100	
15	20	52	18.5	25	58.5	30	40	60	30	40	55	37	50	62	37	50	54	45	60	54	55	75	60							



WIRING DIAGRAMS

CONTACTORS

CONTROL EXAMPLES:

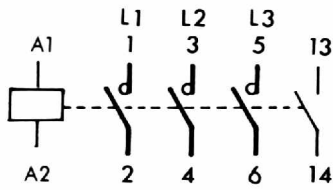

HR..10 HM..10

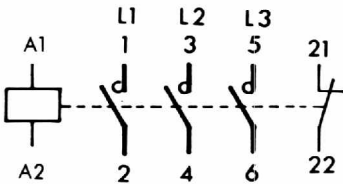

HR..01 HM..01



With Run-Stop switch (or remote pilot)

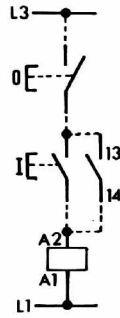

With Run-Stop buttons (only for HR..10)

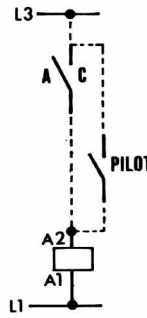

With pilot and Auto-Continuous switch



With pilot and Run-Stop switch

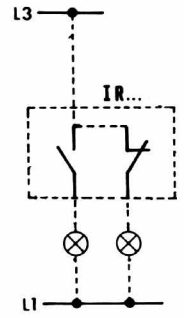

Operation-Stop indication

DIRECT STARTERS (series HS)

IN WATERPROOF ENCLOSURES IP65 Y

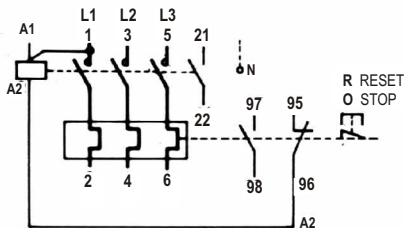

HS..10

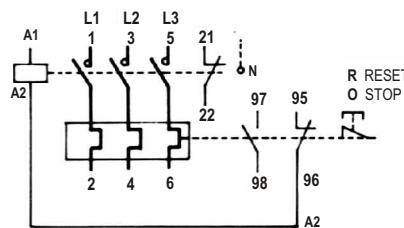

HS..01

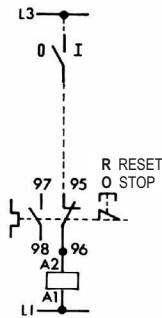

With Run-Stop switch (or remote pilot)

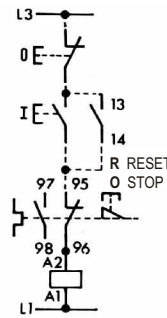

With Run-Stop buttons (only for HS..10)

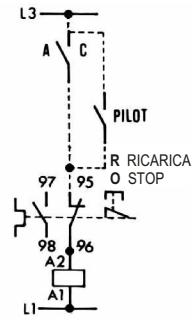

With pilot and Autom-Continuous switch

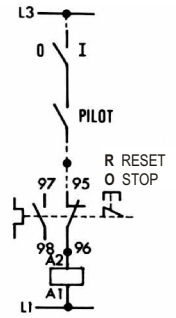

With pilot and Run-Stop switch

IN WATERPROOF ENCLOSURES IP65 WITH RUN-STOP/RESET BUTTONS YP

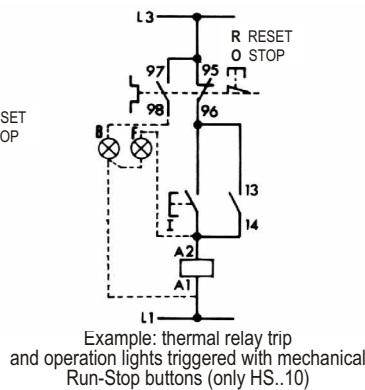
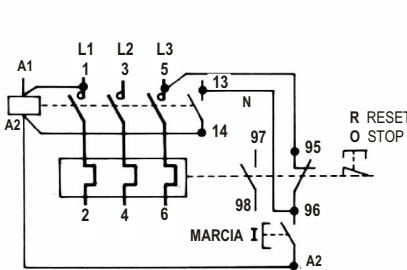

Example: thermal relay trip and operation lights triggered with mechanical Run-Stop buttons (only HS..10)

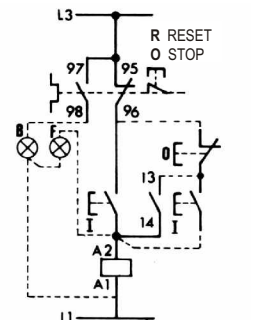

Control with remote Run-Stop buttons and trip and operation lights trigger (only HS..10)

FOR SINGLE-PHASE LOADS

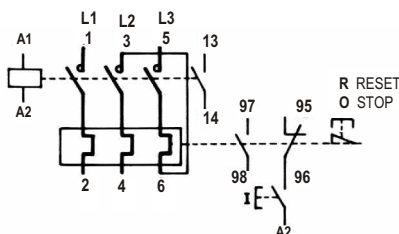

For single-phase loads, connect two poles of the thermal relay in series to obtain heating of the three bimetals.

USER CATEGORIES

Nature of the current	User categories	Typical applications
Alternating current	AC-1	Non-inductive or low inductive loads, heating element ovens
	AC-2	Slip-ring motors: start up, stop
	AC-3	Cage motors: start up, stop of the motor during running (1)
	AC-4	Cage motors: start-up, reverse-current braking, pulsed switching
	AC-5a	Control of discharge lamps
	AC-5b	Control of incandescent lamps
	AC-6a	Control of transformers
	AC-6b	Control of capacitor batteries
	AC-7a	Light inductive loads in domestic and similar applications
	AC-7b	Motor loads in domestic applications
Direct current	DC-1	Non-inductive or low inductive loads, heating element ovens
	DC-3	Shunt motors: start-up, reverse current braking, pulsed switching. Dynamic braking of direct current motors
	DC-5	Motors in series: start-up, reverse current braking, pulsed switching. Dynamic braking of direct current motors
	DC-6	Control of incandescent lamps

1)Equipment classified in category AC-3 may be used for occasional pulsed switching or reverse current braking, for limited periods such as those relative to positioning the machine. During these limited periods, the number of these operations must not exceed 5 per minute and exceed 10 in a period of 10 minutes.

2)Motors for refrigerator hermetic compressors are a combination composed of motor and compressor enclosed in the same casing without external shaft, as the motor operates immersed in the coolant.

USER CATEGORIES FOR SWITCHING ELEMENTS

Current type	Category	Typical applications
Alternating current	AC-12	Control of resistive loads and solid state loads with isolation obtained with opto-isolators
	AC-13	Control of solid state loads with isolating transformer
	AC-14	Control of small electromagnetic loads (= 72 VA)
	AC-15	Control of electromagnetic loads (> 72 VA)
Direct current	DC-12	Control of resistive loads and solid state loads with isolation obtained with opto-isolators
	DC-13	Control of electromagnets
	DC-14	Control of electromagnetic loads with economizing resistors in the circuit