

# SHORT CASE AXIAL FANS

## AIC SERIES

➔ short case ducted

### DESCRIPTION:

The short case ducted helical fans of the AIC series are designed to be installed in ventilation and air conditioning systems of industrial type, where high air volumes at relatively low pressure are required. Compared with centrifugal fans, being in alignment with the ducts, these models are easier to install.

The design features of these fans make them suitable to be installed not only at the beginning of the ducts, but also at the end or in any intermediate section of these ducts.



### MAIN FEATURES:

- Galvanized steel structure with fixing flanges on both extremities.
- Wing-shape profile impeller blades in thermoplastic PPG resin and aluminium hub.
- Self-ventilated motor - Class F - IP55 - "LONG LIFE" ball bearings.
- For continuous operation in environments with temperature range  $-25^{\circ}\text{C} \div +40^{\circ}\text{C}$ .
- 2 speed motor models controlled by a three-phase polarity switch, not supplied as an accessory but easy to find on sale.

### ACCESSORIES:

- Phase slicing speed regulator for mono-phase motors.
- Simple silencer.
- Nose cone silencer.
- Collar fixing flange.
- Inlet nozzle.
- Antivibration joint.
- Fan fixing supports.
- Safety protection grille for the impeller side.
- Safety protection grille for the motor side as accessory, but supplied already installed on the fan.

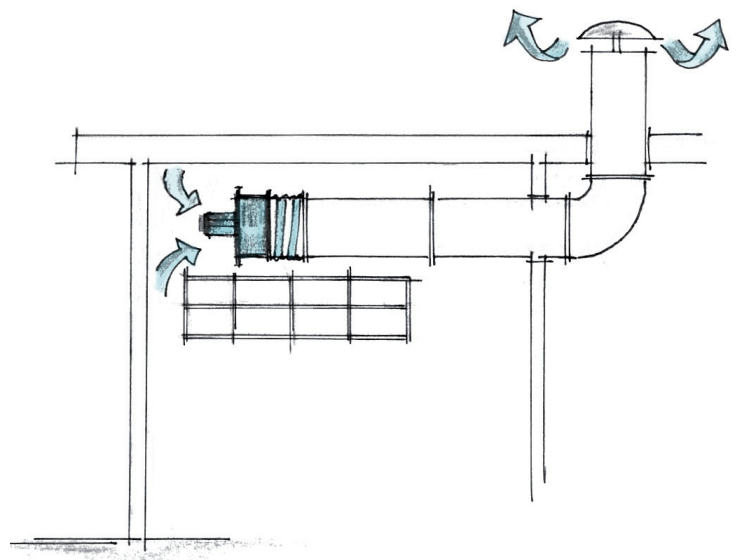

# DIMENSIONS

MODEL	ØA	ØB	ØC	D	ØE	N°
AIC 250	260	300	340	240	12,5	8
AIC 310	315	355	395	240	12,5	8
AIC 350	358	395	438	240	12,5	8
AIC 400	410	450	490	240	12,5	8
AIC 450	468	500	548	240	12,5	8
AIC 500	516	560	596	240	12,5	12
AIC 560	564	620	644	260	12,5	12
AIC 630	640	690	720	260	12,5	12

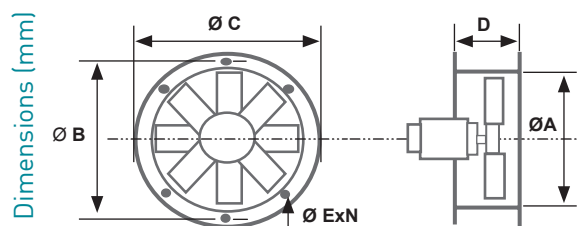

# TECHNICAL SPECIFICATIONS

AIC SHORT CASE SERIES - MONOPHASE

230V - 50HZ

CODE	MODEL	m³/hr	Pt max mmH <sub>2</sub> O	Ref. curves	Rpm nom.	MOTOR				dB(A) 3mt	Kg
						Kw	A	Cl. Is.	IP		
<b>2 POLES</b>											
AP10070	AIC 252 M	1450	46	1	2800	0,12	1,25	F	55	60	19
AP10071	AIC 312 M	2750	58	2	2800	0,25	1,7	F	55	63	26
AP10072	AIC 352 M	6100	75	3	2800	1,1	7,4	F	55	69	40
<b>4 POLES</b>											
AP10073	AIC 254 M	1350	11,5	7	1400	0,09	0,9	F	55	48	18
AP10074	AIC 314 M	2350	15	8	1400	0,12	1,04	F	55	52	25
AP10076	AIC 404 M	4650	21	10	1400	0,25	2,2	F	55	59	42
AP10077	AIC 454 M	5750	28	11	1400	0,37	3,1	F	55	61	54
AP10078	AIC 504 M	7700	33	12	1400	0,55	3,9	F	55	64	58
AP10079	AIC 564 M	12000	36	13	1400	1,1	7	F	55	68	72

AIC SHORT CASE SERIES - THREE-PHASE

230V Δ - 400V λ - 50Hz

CODE	MODEL	m³/hr	Pt max mmH <sub>2</sub> O	Ref. curves	Rpm nom.	MOTOR				dB(A) 3mt	Kg.	
						Kw	A(230VΔ)	A(400Vλ)	Cl. Is.			IP
<b>2 POLES</b>												
AP10093	AIC 402 T	9800	93	4	2800	2,2	8,17	4,7	F	55	75	49
AP10094	AIC 452 T	12100	125	5	2800	3	10,6	6,1	F	55	78	62
AP10095	AIC 502 T	16100	120	6	2800	4	13	7,5	F	55	78	70

## AIC SHORT CASE SERIES - THREE-PHASE

230V Δ - 400V λ - 50Hz

CODE	MODEL	m <sup>3</sup> /hr	Pt max mmH <sub>2</sub> O	Ref. curves	Rpm nom.	MOTOR				dB(A) 3mt	Kg.	
						Kw	A(230VΔ)	A(400Vλ)	Cl. Is.			
<b>4 POLES</b>												
AP10099	AIC 404 T	4650	21	10	1400	0,25	1,4	0,81	F	55	59	42
AP10100	AIC 454 T	5750	28	11	1400	0,37	1,9	1,1	F	55	61	54
AP10101	AIC 504 T	7700	33	12	1400	0,55	2,6	1,5	F	55	64	58
AP10102	AIC 564 T	12000	36	13	1400	1,1	4,8	2,8	F	55	68	72
AP10103	AIC 634 T	15400	44	14	1400	1,5	6,2	3,6	F	55	70	80
<b>6 POLES</b>												
AP10104	AIC 566 T	8750	15,5	15	950	0,37	2	1,15	F	55	60	65
AP10105	AIC 636 T	11600	18	16	950	0,55	2,8	1,6	F	55	62	75
<b>8 POLES</b>												
AP10106	AIC 568 T	6650	9	17	700	0,18	1,5	0,86	F	55	54	65
AP10107	AIC 638 T	8800	10,5	18	700	0,25	1,9	1,1	F	55	56	75

## AIC SHORT CASE SERIES - 2 SPEED THREE-PHASE

400V - 50HZ

CODE	MODEL	m <sup>3</sup> /hr	Pt max mmH <sub>2</sub> O	Ref. curves	Rpm nom.	MOTOR				dB(A) 3mt	Kg.	
						Kw	A	Cl. Is.	IP			
<b>2 - 4 POLES</b>												
AP10130	AIC 352-4 DT	6100/3050	75/18	3	9	2800/1400	1,1/0,25	2,5/0,85	F	55	69/54	40
AP10131	AIC 402-4 DT	9800/4650	93/21	4	10	2800/1400	2,5/0,66	5,1/1,5	F	55	75/59	52
AP10132	AIC 452-4 DT	12100/5750	125/28	5	11	2800/1400	3,3/0,81	6,6/1,6	F	55	78/61	64
AP10133	AIC 502-4 DT	16100/7700	120/33	6	12	2800/1400	4,7/1,1	10,3/2,3	F	55	78/64	71
<b>4 - 6 POLES</b>												
AP10134	AIC 564-6 DT	12000/8750	36/15,5	13	15	1400/950	1,1/0,37	2,8/1,15	F	55	68/60	75
AP10135	AIC 634-6 DT	15400/11600	44/18	14	16	1400/950	1,7/0,6	3,8/1,7	F	55	70/62	84
<b>6 - 8 POLES</b>												
AP10136	AIC 566-8 DT	8750/6650	15,5/9	15	17	950/700	0,37/0,15	1,15/0,7	F	55	60/54	72
AP10137	AIC 636-8 DT	11600/8800	18/10,5	16	18	950/700	0,66/0,33	1,8/1,25	F	55	62/56	81

# ACCESSORIES

## SL SERIES SIMPLE SILENCER

- Galvanized steel external cylindrical body, with inside covering in sound proof mineral wool with a density of 70 Kg/m<sup>3</sup>, covered on the surface with glass fibre layer with an M ZERO fire resistance class.
- The inner surface of the silencer is composed from a micro stretched wire net. Threaded inserts on the extremities allow the silencer to be fixed onto the duct's flanges.
- Installed silencers can be of three different lengths: 1, 1.5, 2 times the fan internal diameter; wherever possible, it is recommended to install them on the inlet side.
- The application of this type of silencer affects marginally fan performances but consistently reduce the noise level produced by the ventilation system.

Installation examples

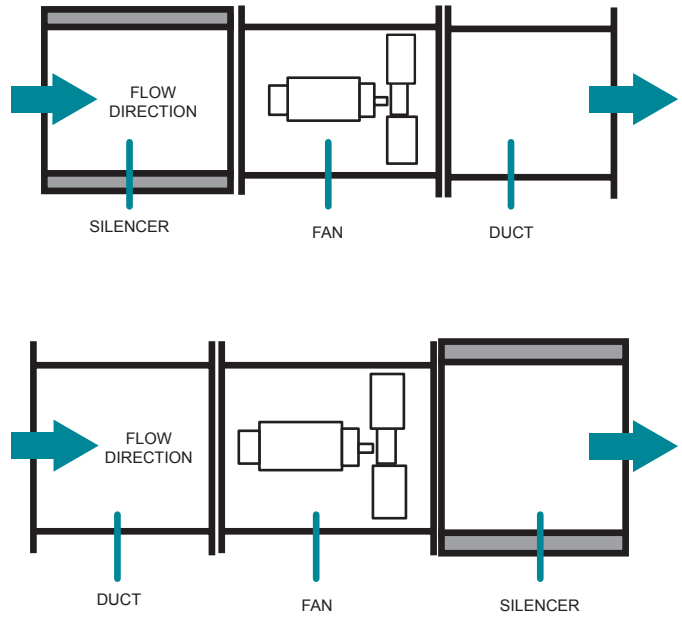

CODE	MODEL	ØA	ØB	ØC	D	MA	N°	Kg.
AP19010	SL 400-1	400	450	540	400	10	8	12
AP19011	SL 400-2				600			18
AP19012	SL 400-3				800			22
AP19013	SL 450-1	450	500	610	450	10	8	15
AP19014	SL 450-2				675			21
AP19015	SL 450-3				900			25
AP19016	SL 500-1	500	560	660	500	10	12	18
AP19017	SL 500-2				750			26
AP19018	SL 500-3				1000			33
AP19019	SL 560-1	560	620	720	560	10	12	22
AP19020	SL 560-2				840			29
AP19021	SL 560-3				1120			36
AP19022	SL 630-1	630	690	790	630	10	12	25
AP19023	SL 630-2				945			34
AP19024	SL 630-3				1260			44

Dimensions (mm)

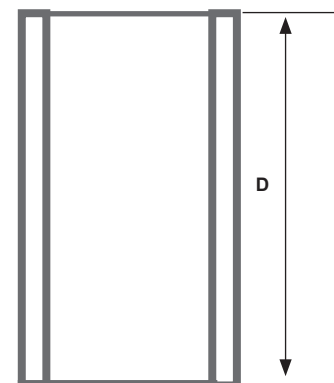
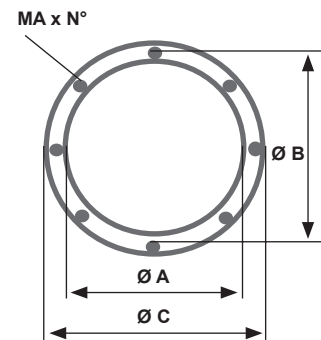

## SILENCER WITH POD SLO SERIES

- Galvanized steel external cylindrical body, with inside covering in sound proof mineral wool with a density of  $70 \text{ Kg/m}^3$ , covered on the surface with glass fibre layer with an M ZERO fire resistance class.
- The inner surface of the silencer is composed by a micro stretched wire net. Threaded inserts on the extremities allow the silencer to be fixed onto the duct's flanges.
- Installed silencers can be of three different lengths: 1, 1.5, 2 times the fan's internal diameter; wherever possible, it is recommended to install them on the aspiration side.
- For the SLO silencer installation, a duct with a length of minimum one fan's diameter has to be inserted between the silencer and the fan.
- The application of the SLO pod silencer, having a greater noise level damping, unfortunately generates additional airloss to the ventilation system depending of the airflow (see tab. A).

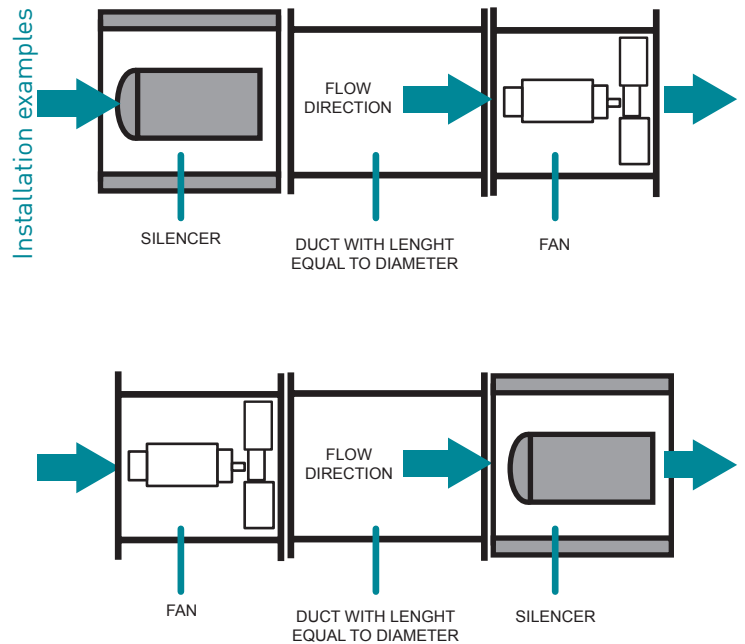

CODE	MODEL	ØA	ØB	ØC	D	ØE	MA	N°	Kg.
AP19059	SLO 400-1	400	450	540	400	200	10	8	14
AP19060	SLO 400-2				600				22
AP19061	SLO 400-3				800				26
AP19062	SLO 450-1	450	500	610	450	250	10	8	17
AP19063	SLO 450-2				675				25
AP19064	SLO 450-3				900				30
AP19065	SLO 500-1	500	560	660	500	250	10	12	23
AP19066	SLO 500-2				750				32
AP19067	SLO 500-3				1000				40
AP19068	SLO 560-1	560	620	720	560	300	10	12	28
AP19069	SLO 560-2				840				38
AP19070	SLO 560-3				1120				45
AP19071	SLO 630-1	630	690	790	630	300	10	12	32
AP19072	SLO 630-2				945				45
AP19073	SLO 630-3				1260				56

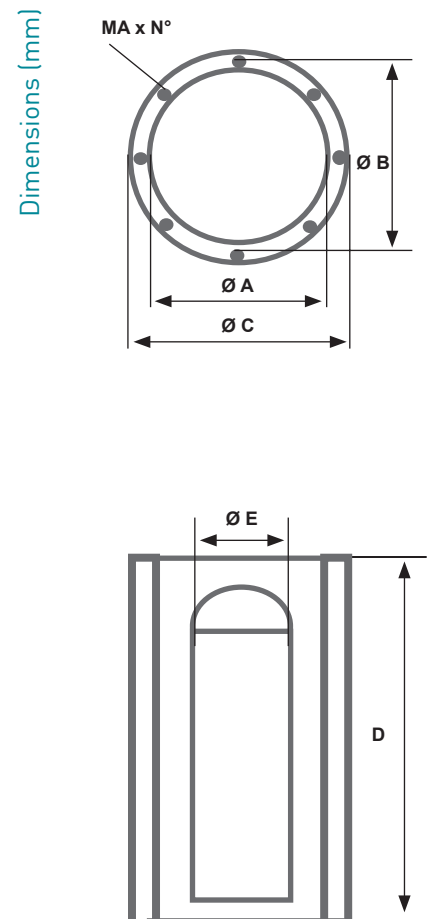

## TAB. A - AIRLOSS DIAGRAM

### ADDITIONAL AIRLOSS OF SILENCERS WITH POD SLO SERIES

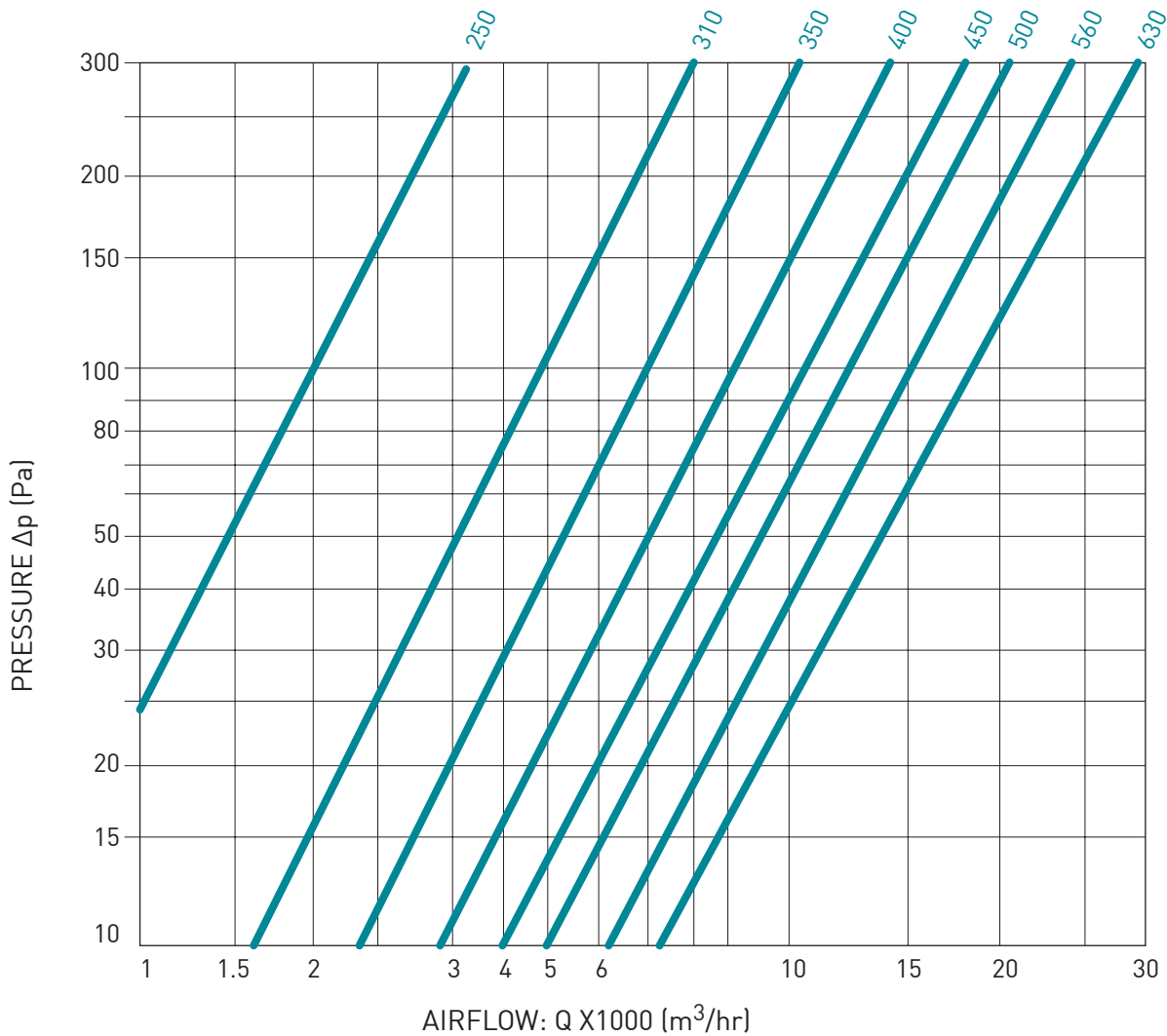

### SAFETY PROTECTION GRILLES

The GP safety protection grilles must be installed in case the moving parts of the fan are accessible and are suitable for installation on:  
Impeller side of the AIC series fans.

The GPM safety protection grilles must be installed in case the moving parts of the fan are accessible, and are suitable for installation on:  
Motor side of the AIC series fans.

On request, this accessory can be supplied already mounted on the fan.

#### CODE MODEL

AP19173	GP 400
AP19174	GP 450
AP19175	GP 500
AP19176	GP 560
AP19177	GP 630

#### CODE MODEL

AP19185	GPM 250
AP19186	GPM 310
AP19187	GPM 350
AP19188	GPM 400
AP19189	GPM 450
AP19190	GPM 500
AP19191	GPM 560
AP19192	GPM 630

## COLLAR FIXING FLANGE

CODE	MODEL	ØA	ØB	ØC	D	ØE	N°	Kg
AP19103	CFC 400	410	450	490	80	12	8	4,2
AP19104	CFC 450	468	500	548	80	12	8	5,3
AP19105	CFC 500	516	560	596	80	12	12	6,5
AP19106	CFC 560	564	620	644	80	12	12	7
AP19107	CFC 630	640	690	720	80	12	12	8,3

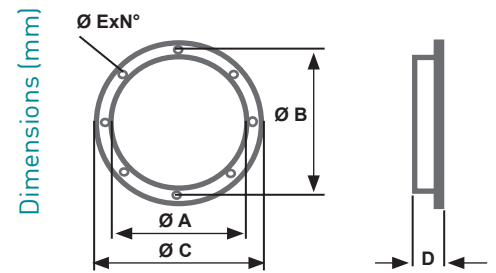

## INLET NOZZLE

CODE	MODEL	ØA	ØB	ØC	D	ØE	N°	Kg
AP19118	BAS 400	410	450	490	140	12	8	4,2
AP19119	BAS 450	468	500	548	140	12	8	5,3
AP19120	BAS 500	516	560	596	180	12	12	6,5
AP19121	BAS 560	564	620	644	180	12	12	7
AP19122	BAS 630	640	690	720	180	12	12	8,3

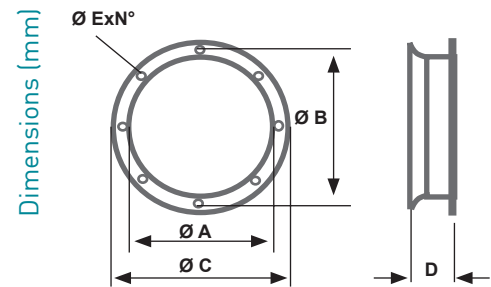

## ANTIVIBRATION JOINT

CODE	MODEL	ØA	ØB	ØC	D	ØE	N°	Kg
AP19134	GAV 400	410	450	490	200	12	8	6
AP19135	GAV 450	468	500	548	200	12	8	7
AP19136	GAV 500	516	560	596	200	12	12	8
AP19137	GAV 560	564	620	644	200	12	12	10
AP19138	GAV 630	640	690	720	200	12	12	12

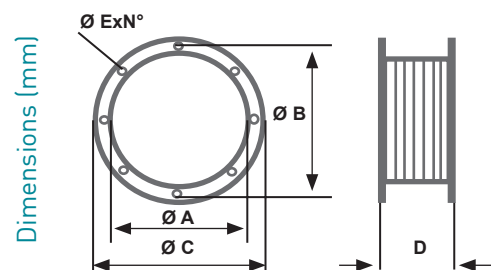

## PAIR OF FIXING SUPPORTS

CODE	MODEL	ØA	B	C	D	E	F	ØG	Kg. Un
AP19153	SFV 400	410	350	270	290	15	30	10x20	2
AP19154	SFV 450	468	400	300	330	15	30	10x20	2,2
AP19155	SFV 500	516	430	340	380	15	30	10x20	3
AP19156	SFV 560	564	470	370	420	15	30	10x20	3,5
AP19157	SFV 630	640	550	430	500	15	30	10x20	4

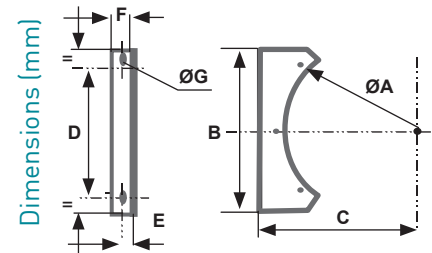

## MONOPHASE SPEED REGULATORS

CODE	MODEL	to control models of the AIC series
AP2568	RDV 1,5-MF	254M
AP2600	RDV 3-MF	314M, 354M, 404M



CODE	MODEL	to control models of the AIC series
AP2642	RDV 5-MF	454M, 504M

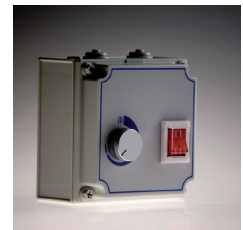



# CHARACTERISTIC CURVES

## AIC SERIES - 2 POLES - 2800 RPM

1	252 M 252 T	3	352 M, 352 T 352-4 DT (2 poles)	5	452 T 452-4 DT (2 poles)
2	312 M 312 T	4	402 T 402-4 DT (2 poles)	6	502 T 502-4 DT (2 poles)

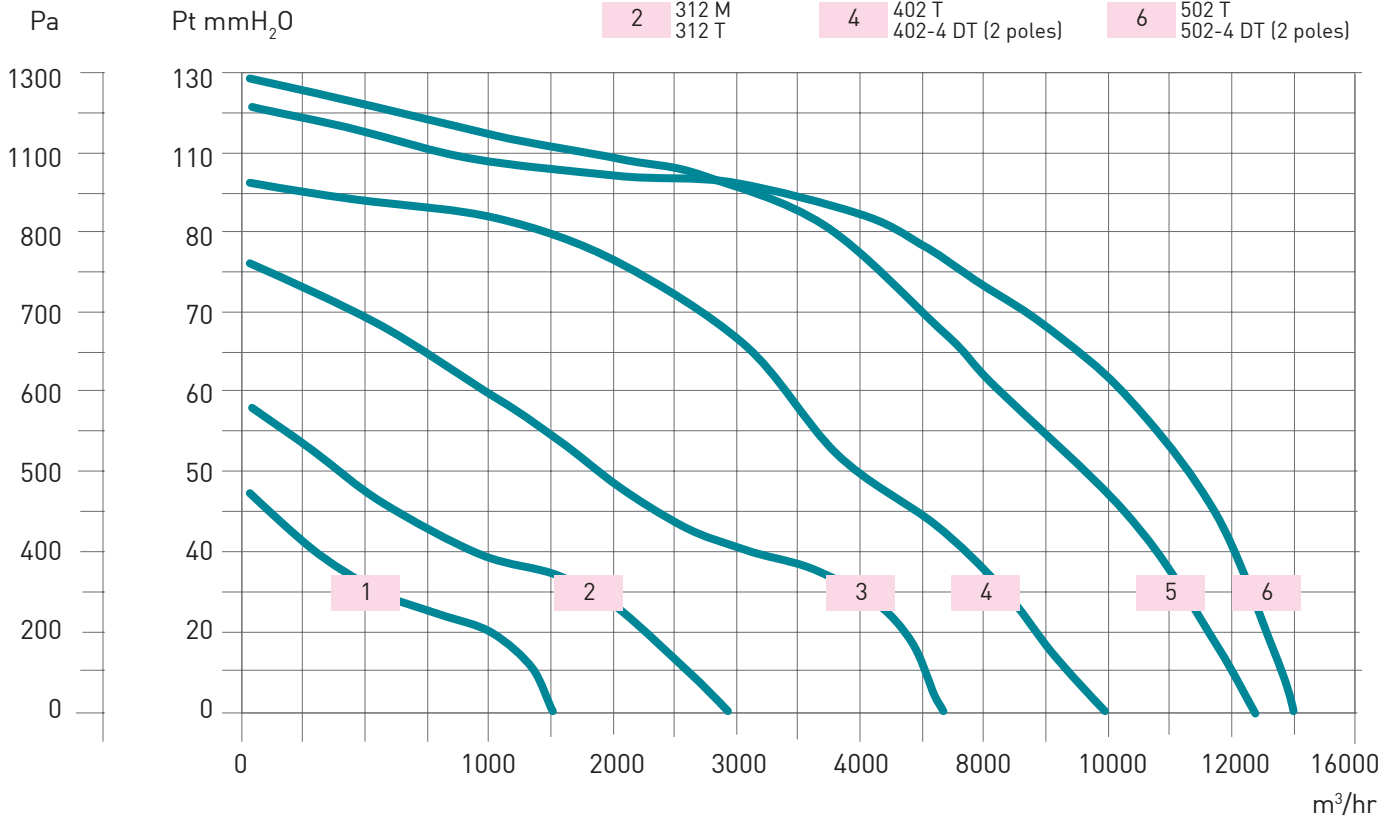

## AIC SERIES - 4 POLES - 1400 RPM

7	254 M 254 T	10	404 M, 404 T 402-4 DT (4 poles)	13	564 M 564 T
8	314 M 314 T	11	454 M, 454 T 452-4 DT (4 poles)	14	634 T
9	354 M, 354 T 352-4 DT (4 poles)	12	504 M, 504 T 502-4 DT (4 poles)		

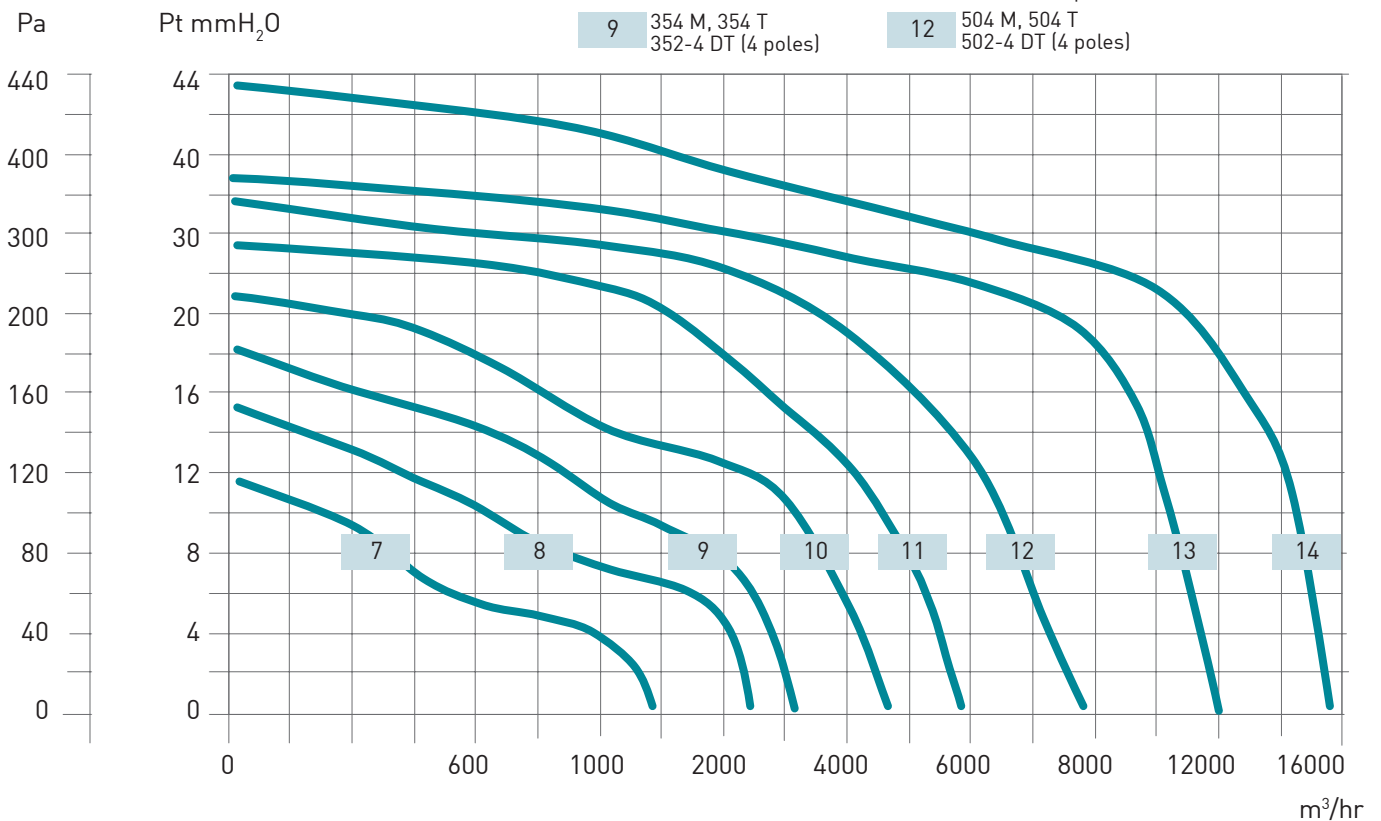

AIC SERIES - 6 POLES - 950 RPM

15 566 T  
564-6 DT (6 poles)  
566-8 DT (6 poles)

16 636 T  
634-6 DT (6 poles)  
636-8 DT (6 poles)

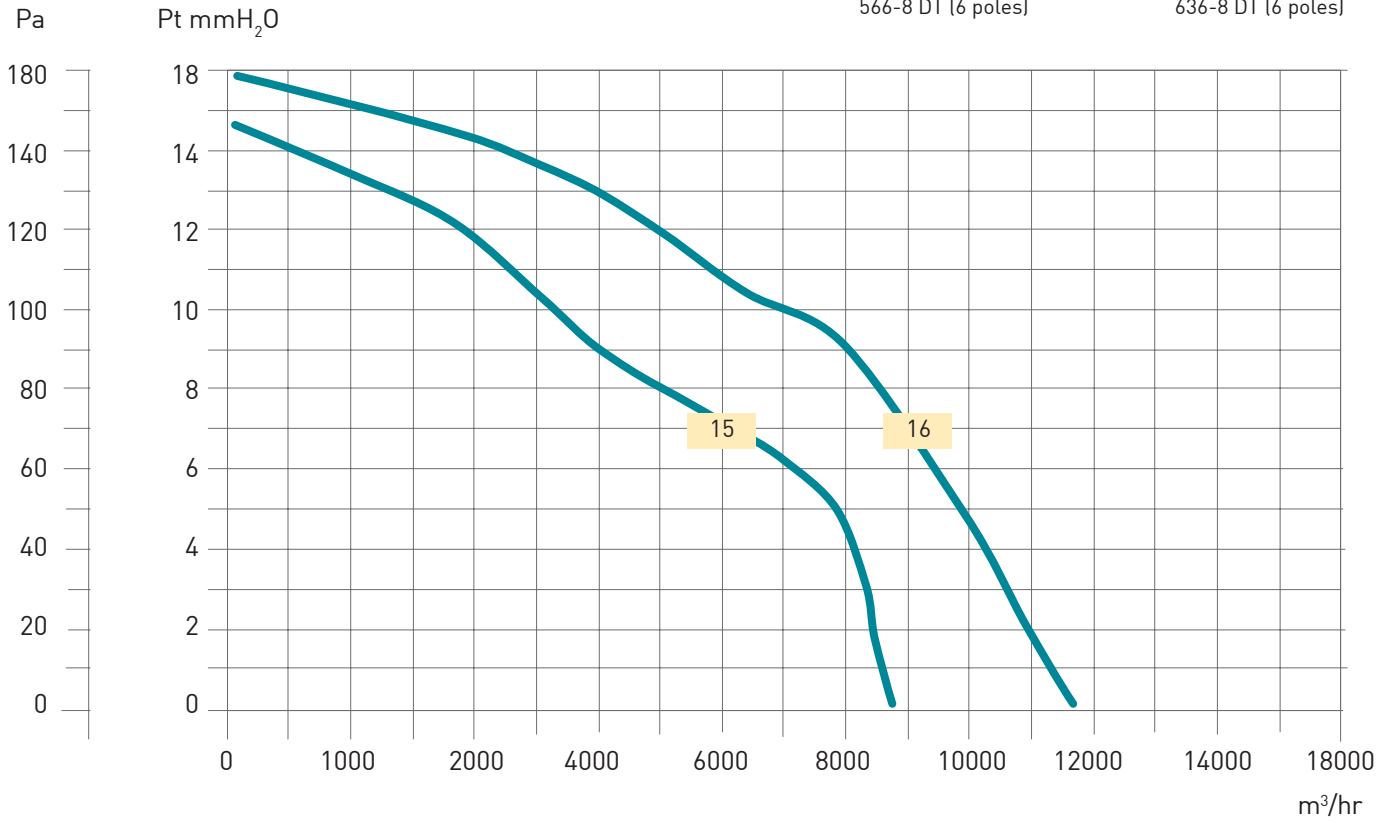

AIC SERIES - 8 POLES - 750 RPM

17 568 T  
566-8 DT (8 poles)

18 638 T  
636-8 DT (8 poles)

